



WHEEL SPACERS
CATALOG 2022 **V.2**

NOTES

- A** Wheel spacers with **5 mm** thickness, generally, do not need to replace the original studs or bolts. However, we recommend checking that the usable length of the thread is **AT LEAST EQUAL TO** its diameter.
- B** The wheel spacers can only be fitted into **steel rims or original alloy wheels**.
- C** The wheel spacers can only be fitted into **steel rims and aftermarket alloy rims with conical seat**.
- D** The wheel spacers can only be fitted into the **front axle**.
- E** Those cars may have different stud bolts depending on model and manufacturing year. Pay attention to the original spline diameter on the front and rear axles. The stud bolts included in the kit have a spline diameter of **13 mm (M12x1.25)**. If the original stud bolts have a different diameter, please specify it in your order.
- F** The kit is supplied with stud bolts of **70 mm** length and spline diameter of **15 mm**.
- G** The kit is supplied with stud bolts of **60 mm** length and spline diameter of **15 mm**.
- H** Wheel spacer with external **centering**.
- I** Those cars may have different stud bolts depending on model and manufacturing year. Pay attention to the original spline diameter on the front and rear axles. The stud bolts included in the kit have a spline diameter of **14.3 mm (M12x1.25)**. If the original stud bolts have a different diameter, please specify it in your order.
- J** The kit includes polished chrome bolts equal to **Ferrari** and **Maserati** originals, with shaft length of **75 mm**.
- K** The kit includes polished chrome bolts identical to **Ferrari** and **Maserati** originals, with shaft length of **70 mm**.
- L** Those cars may have different stud bolts depending on model and manufacturing year. Pay attention to the original spline diameter on the front and rear axles. The stud bolts included in the kit have a spline diameter of **14.2 mm (M12x1.50)**. If the original stud bolts have a different diameter, please specify it in your order.
- M** Your wheels must be equipped with **lightening holes**. The wheel hubs must disappear into the wheel.
- N** The kits include **bolts similar to those for original** alloy wheel rims or aftermarket alloy wheels **with spherical seating**.
- O** Those cars may have different stud bolts depending on model and manufacturing year. Pay attention to the original spline diameter on the front and rear axles. The stud bolts included in the kit have a spline diameter of **12.2 mm (M12x1.50)**. If the original stud bolts have a different diameter, please specify it in your order.
- P** The wheel spacers can only be fitted into the front axles with **aftermarket alloy rims and bolts** with conical seating.
- Q** The wheel spacers can only be fitted into the **rear axle**.
- R** Those cars may have different stud bolts depending on model and manufacturing year. Pay attention to the original spline diameter on the front and rear axles. The stud bolts included in the kit have a spline diameter of **13mm (M12x1.50)**. If the original stud bolts have a different diameter, please specify it in your order.
- S** The wheel spacers can only be fitted into **original Citroën - Peugeot - Fiat alloy wheel rims with flat seat**.
- T** The wheel spacers can only be fitted into the front axle with **original and aftermarket alloy wheel rims** and bolts with spherical seating.
- U** The wheel spacers can only be fitted into **steel wheel rims**.
- V** The kit includes polished chrome bolts identical to **Ferrari** and **Maserati** originals, with shaft length of **66 mm**.
- W** The kit includes polished chrome bolts identical to **Maserati** originals, with shaft length of **52 mm**.
- X** The kit includes polished chrome bolts identical to **Maserati** originals, with shaft length of **48 mm**.
- Y** Wheel spacers **without** external centering ring.
- Z** The wheel spacers can only be fitted into **original VW-group** alloy wheels with **5x45° chamfer**
- Z1** The wheel spacers can only be fitted into **original VW-group** alloy wheels with **6,5x45° chamfer**
- Z2** The wheel spacers **cannot** be installed on **Peugeot 406** equipped with original **BBS alloy wheels**.

NOTE

A I distanziali a spessore **5 mm**, generalmente, non necessitano la sostituzione delle colonnette o dei bulloni originali. Consigliamo comunque di verificare che la lunghezza utile del filetto sia **ALMENO PARI** al diametro dello stesso.

B Distanziali installabili esclusivamente su **cerchi in acciaio o in lega originali**.

C Distanziali installabili esclusivamente su cerchi in **lega aftermarket e/o originali in ferro con sede conica**.

D Distanziali installabili esclusivamente sull'**asse anteriore**.

E Le auto in oggetto possono montare colonnette differenti a seconda dell'anno di costruzione e del modello. Consigliamo di **verificare sempre** i diametri originali dello zigrino millerighe dell'asse anteriore e posteriore. Le colonnette incluse nel kit hanno un diametro zigrino di **13mm (M12x1,25)**. Qualora le originali fossero di diametro diverso, vi invitiamo a specificarlo nell'ordine.

F Il kit viene fornito con colonnette lunghe **70 mm** e diametro zigrino di **15 mm**.

G Il kit viene fornito con colonnette lunghe **60mm** e diametro zigrino di **15 mm**.

H Distanziale **con centraggio** esterno.

I Le auto in oggetto possono montare colonnette differenti a seconda dell'anno di costruzione e del modello. Consigliamo di **verificare sempre** i diametri originali dello zigrino millerighe dell'asse anteriore e posteriore. Le colonnette incluse nel kit hanno un diametro zigrino di **14,3mm (M12x1,25)**. Qualora le originali fossero di diametro diverso, vi invitiamo a specificarlo nell'ordine.

J Il kit include bulloneria cromata lucida identica all'originale **Ferrari e Maserati** con lunghezza sottocono di **75 mm**.

K Il kit include bulloneria cromata lucida identica all'originale **Ferrari e Maserati** con lunghezza sottocono di **70 mm**.

L Le auto in oggetto possono montare colonnette differenti a seconda dell'anno di costruzione e del modello. Consigliamo di **verificare sempre** i diametri originali dello zigrino millerighe dell'asse anteriore e posteriore. Le colonnette incluse nel kit hanno un diametro zigrino di **14,2mm (M12x1,50)**. Qualora le originali fossero di diametro diverso, vi invitiamo a specificarlo nell'ordine.

M I cerchi devono avere le **cave di alleggerimento**. Le colonnette originali del mozzo ruota devono andare completamente a scomparsa nelle cave di alleggerimento.

N I kit comprendono **bulloni simili all'originale** per ruote in lega originali o con ruote in lega aftermarket **con sede sferica**.

O Le auto in oggetto possono montare colonnette differenti a seconda dell'anno di costruzione e del modello. Consigliamo di **verificare sempre** i diametri originali dello zigrino millerighe dell'asse anteriore e posteriore. Le colonnette incluse nel kit hanno un diametro zigrino di **12,2mm (M12X1,50)**. Qualora le originali fossero di diametro diverso, vi invitiamo a specificarlo nell'ordine.

P Distanziali installabili esclusivamente sull'asse anteriore con **cerchi in lega aftermarket** con bullone a sede conica.

Q Distanziali installabili esclusivamente sull'**asse posteriore**.

R Le auto in oggetto possono montare colonnette differenti a seconda dell'anno di costruzione e del modello. Consigliamo di **verificare sempre** i diametri originali dello zigrino millerighe dell'asse anteriore e posteriore. Le colonnette incluse in questo kit hanno un diametro zigrino di **13mm (M12x1,50)**. Qualora le originali fossero di diametro diverso, vi invitiamo a specificarlo nell'ordine.

S Distanziali installabili esclusivamente su cerchi **in lega originali con sede piatta Citroën - Peugeot - Fiat**.

T Distanziali installabili esclusivamente sull'asse anteriore con **cerchi in lega originali e aftermarket** con bullone a sede sferica.

U Distanziali installabili esclusivamente su **cerchi in acciaio**.

V Il kit include bulloneria cromata lucida identica all'originale **Ferrari e Maserati** con lunghezza sottocono di **66 mm**.

W Il kit include bulloneria cromata lucida identica all'originale **Maserati** con lunghezza sottocono di **52 mm**.

X Il kit include bulloneria cromata lucida identica all'originale **Maserati** con lunghezza sottocono di **48 mm**.

Y Distanziali **senza** centraggio esterno.

Z Distanziali installabili esclusivamente su **cerchi in lega originali del gruppo VW** che presentano uno smusso di misura **5x45°**

Z1 Distanziali installabili esclusivamente su **cerchi in lega originali del gruppo VW** che presentano uno smusso di misura **6,5x45°**

Z2 Distanziali **non** installabili su **Peugeot 406** dotata di cerchi in lega **BBS originali**.

NOTE CHIAVE

- *Key note 1** Solo asse anteriore
- *Key note 2** Solo asse posteriore
- *Key note 3** Versione benzina
- *Key note 4** Versione diesel
- *Key note 5** 3 fori
- *Key note 6** 4 fori
- *Key note 7** 5 fori
- *Key note 8** Le vetture prodotte precedentemente ad AGOSTO/2003 montano bulloni originali con chiave da 19 mm. Verificare la chiave in dotazione con la vettura
- *Key note 9** Le vetture prodotte successivamente ad AGOSTO/2003 montano bulloni originali con chiave da 17 mm. Verificare la chiave in dotazione con la vettura
- *Key note 10** Le vetture prodotte successivamente a GENNAIO/1999 montano bulloni originali con chiave da 17 mm. Verificare la chiave in dotazione con la vettura
- *Key note 11** Le vetture prodotte precedentemente a GENNAIO/1999 montano bulloni originali con chiave da 19 mm. Verificare la chiave in dotazione con la vettura
- *Key note 12** Bulloneria cromata lucida
- *Key note 13** Verificare lunghezza sottocono (x) del bullone originale
- *Key note 14** Bulloni con rondella mobile per cerchi in lega originali
- *Key note 15** Con colonnette
- *Key note 16** O-P2073CD installabili su auto immatricolate prima del 2008
- *Key note 17** Mercedes per ogni modello di cerchio originale usa bulloni con lunghezze differenti. Quindi è necessario misurare l'effettiva lunghezza del bullone da sotto testa/sfera, e segnalarlo al momento dell'ordine

KEY NOTES

- *Key note 1** Front axle only
- *Key note 2** Rear axle only
- *Key note 3** Gasoline version
- *Key note 4** Diesel version
- *Key note 5** 3 holes
- *Key note 6** 4 holes
- *Key note 7** 5 holes
- *Key note 8** Vehicles produced before AUGUST/2003 have original bolts with 19 mm hex. Please verify the hex of the standard equipment
- *Key note 9** Vehicles produced later than AUGUST/2003 have original bolts with 17mm hex. Please verify the hex of the standard equipment
- *Key note 10** Vehicles produced later than JANUARY/1999 have original bolts with 17 mm hex. Please verify the hex of the standard equipment
- *Key note 11** Vehicles produced before JANUARY/1999 have original bolts with 19 mm hex. Please verify the hex of the standard equipment
- *Key note 12** Bolts chromium plated polished
- *Key note 13** Please verify the shaft length (x) of the original bolt
- *Key note 14** Bolts with movable washer to fit original alloy wheels
- *Key note 15** With stud bolts
- *Key note 16** O-P2073CD can be fitted on cars registered before 2008
- *Key note 17** Mercedes uses bolts with different lengths for each model of OE wheel. It is thus necessary to measure the real shaft length of the bolt and to specify it in the order

TIPOLOGIE

TYPES

M1

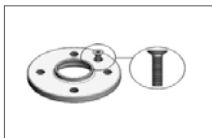

Distanziale senza bulloneria
Wheel spacer without bolts

M2a

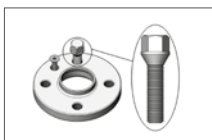

Distanziale con bullone conico
Wheel spacer with conical bolt

M2b

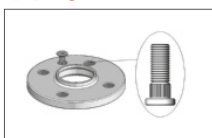

Distanziale con colonnetta a piantaggio
Wheel spacer with stud bolt

M3a

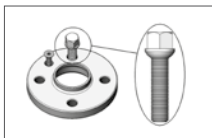

Distanziale con bullone sferico
Wheel spacer with spherical bolt

M3b

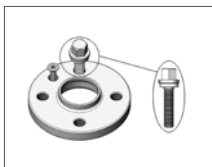

Distanziale con bullone a sede piatta con rondella integrata imperdibile
Wheel spacer with flat bolt and integrated unmovable washer

M4

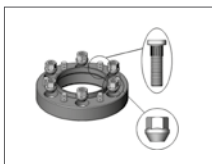

Distanziali a doppia bulloneria con colonnetta premontata e dado
Wheel spacers with double bolts with pre-installed stud bolts and nuts

M5

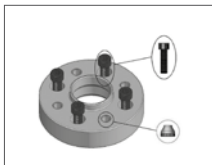

Distanziale a doppia bulloneria con brugola e boccola in acciaio premontata
Wheel spacer with double bolts with socket head screw and pre-installed steel bush

M6

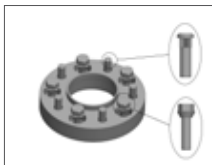

Distanziale a doppia bulloneria con bullone e colonnetta premontata
Wheel spacer with double bolts with bolts and pre-installed stud bolts

M7

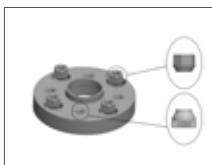

Distanziale a doppia bulloneria con dado e boccola in acciaio premontata
Wheel spacer with double bolts with nuts and pre-installed steel bush

SEDI NEL MONDO E MILESTONE

WORLDWIDE PRESENCE & MILESTONES

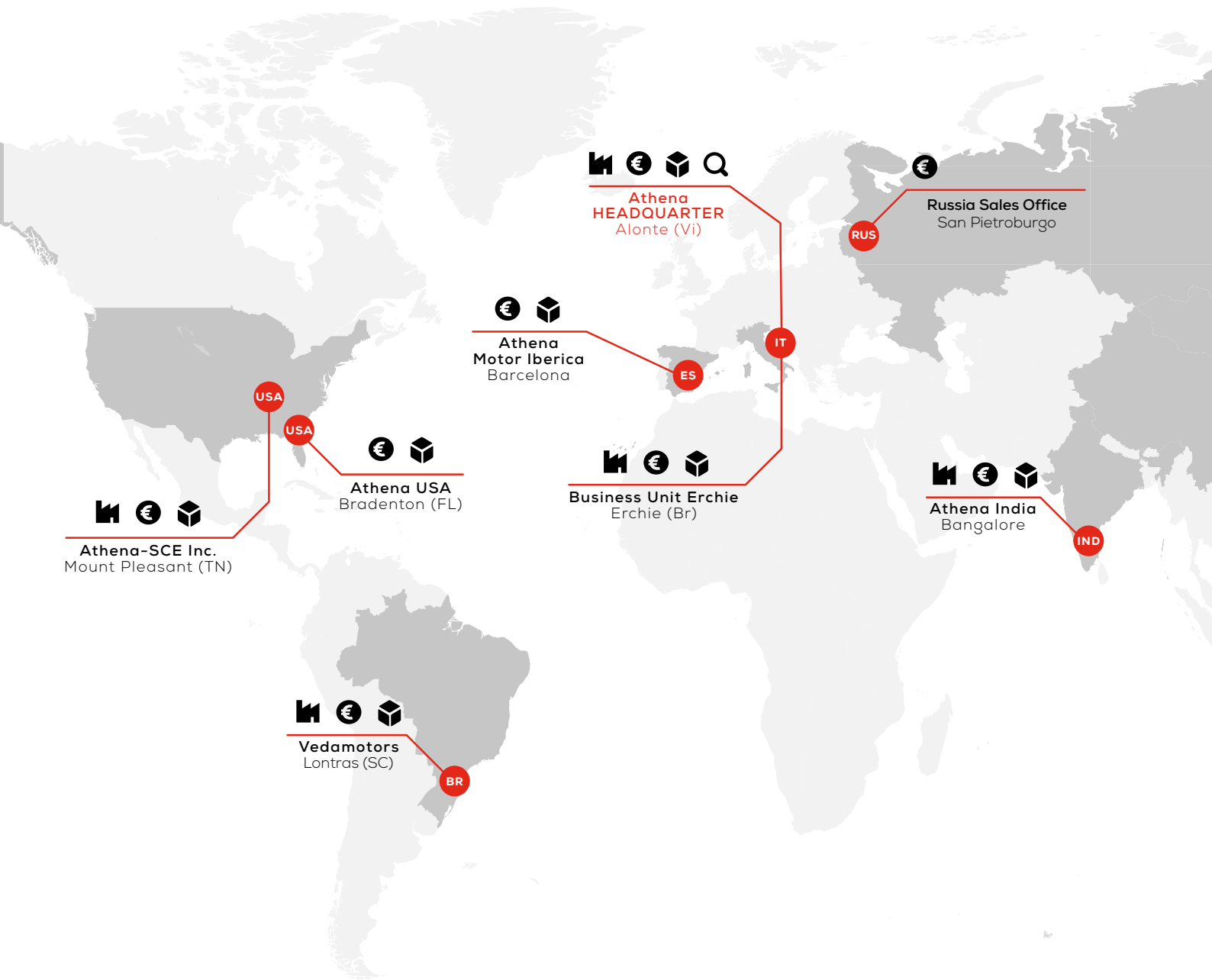

Siti produttivi
Production plants



Punti strategici di approvvigionamento
Strategic sourcing points



Hub Logistici
Logistics hub



Uffici Commerciali
Sales offices



- 2021** **Apertura uffici vendita in Russia**
Opening of a new sales office in St. Petersburg - Russia
- 2019** **Acquisizioni in tutto il mondo**
Acquisitions around the world
- 2018** **Nuovo hub logistico**
The new logistics hub takes shape
- 2016** **Athena sbarca in Cina**
Athena comes to China
- 2011** **Acquisizione brand Guarnitauto**
We acquire the Guarnitauto brand
- 2010** **Athena entra nel mercato Aftermarket Auto Racing**
Athena enters the Automotive Racing Aftermarket world
- 2009** **Nuovo impianto fotovoltaico in HQ**
New solar power system in HQ
- 2008** **Certificazione ISO TS 16949**
ISO TS 16949 Certification
- 2007** **Acquisizione del brand GET**
Athena GETs better
- 2004** **Nasce Athena USA**
Establishment of Athena U.S.A.
- 1998** **Apertura della sede brasiliana**
Athena goes international
- 1987** **Nasce la Divisione Athena Parts**
Athena Parts Division is born
- 1973** **Fondazione di Athena**
Establishment of Athena

INDEX

- 03 Chi siamo
Who we are**
- 05 Caratteristiche tecniche
Technical features**
- 10 Kit distanziali cambio interasse
PCD Adapter Kit**
- 24 Lista Applicazioni
Application List**
 - 25 Abarth
 - 26 Alfa Romeo
 - 29 Audi
 - 30 Audi (off-road)
 - 31 Bentley
 - 32 Bmw
 - 36 Cadillac
 - 36 Chevrolet
 - 37 Chrysler
 - 37 Citroën
 - 39 Dacia
 - 40 Daihatsu
 - 41 Daihatsu (off-road)
 - 41 Daewoo
 - 41 Dodge
 - 42 Ferrari
 - 42 Fiat
 - 45 Fiat (off-road)
 - 46 Ford
 - 48 Ford (off-road)
 - 48 Great wall motor
 - 48 Honda
 - 49 Hyundai
 - 50 Hyundai (off-road)
 - 50 Infiniti
 - 51 Isuzu
 - 51 Jaguar
 - 52 Jeep
 - 52 Kia
 - 53 Kia (off-road)
 - 53 Lamborghini
 - 54 Lancia
 - 56 Land Rover (off-road)
 - 56 Lexus
 - 57 Lotus
 - 57 Maserati
 - 58 Mazda
 - 60 Mercedes
 - 64 Mini by Bmw
 - 65 Mitsubishi
 - 65 Mitsubishi (off-road)
 - 66 Nissan
 - 67 Nissan (off-road)
 - 68 Opel
 - 70 Opel (off-road)
 - 71 Peugeot
 - 73 Porsche
 - 75 Renault
 - 77 Renault (off-road)
 - 77 Rover
 - 78 Saab
 - 78 Seat
 - 79 Skoda
 - 81 Smart by Mercedes
 - 81 Ssangyong (off-road)
 - 82 Subaru
 - 83 Suzuki
 - 83 Suzuki (off-road)
 - 83 Tesla
 - 84 Toyota
 - 85 Toyota (off-road)
 - 86 Volkswagen
 - 87 Volkswagen (off-road)
 - 88 Volvo
- 89 Bulloni & Dadi
Bolts & Nuts**
- 98 Condizioni generali di vendita
General condition of sale**

CHI SIAMO

Athena, nata come piccolo laboratorio artigianale è oggi un'importante realtà produttiva nel panorama mondiale, con 744 dipendenti, 10 sedi nel mondo e un fatturato globale di oltre 120 milioni di euro.

Attiva sul mercato dal 1973, Athena è **leader italiano ed europeo nella produzione di guarnizioni** per applicazioni industriali. L'azienda è un punto di riferimento non solo per la **ricambistica tradizionale**, ma anche per articoli destinati alle quattro ruote da competizione.

Agli articoli di sua produzione, Athena ha poi deciso di affiancare **prodotti di commercializzazione di alto prestigio** per offrire ai suoi clienti una più ampia gamma di soluzioni. I nuovi marchi distribuiti incorporano rigorosamente la filosofia aziendale: serietà, affidabilità, evoluzione tecnica e miglioramento continuo; il tutto rivolto a un mercato competente e sempre più informato ed esigente.

WHO WE ARE

Started from a "garage-like" workshop, **Athena** is now an important manufacturing group with 744 employees, 10 branches around the world and a global turnover exceeding 120 million Euros.

Active on the market since 1973, today Athena is the **European and Italian leader in the production of gaskets** for industrial applications. The company is considered a benchmark not only for the **traditional spare part market, but also for racing vehicle applications.**

Furthermore, in order to offer a wider range of solutions and exhaustive product portfolio, Athena has decided to add a number of **prestigious brands to distribute** alongside its traditional range. The new brands rigorously embrace the core philosophy of the company: seriousness, reliability, technical evolution and continuous improvement, which are key to meet the expectations of an increasingly demanding, informed and qualified consumer.





DISTANZIALI ATHENA, QUALITÀ E ALTE PRESTAZIONI

I distanziali ruota Athena sono ricavati da “pieno”, ovvero da una barra di alluminio di prima qualità e sono lavorati meccanicamente con macchine utensili a controllo numerico CNC che garantiscono la massima precisione. Questo procedimento produttivo, che non prevede punti di fusione, conferisce una resistenza imbattibile ai distanziali riducendone al limite la possibilità di rottura.

La scelta dei materiali, il particolare disegno e la **bulloneria certificata TUV**, permettono di raggiungere la miglior stabilità e affidabilità nel mercato. Grazie al particolare colore “bianco lucido”, i distanziali Athena danno un aspetto accattivante alla vettura valorizzandone i cerchi in lega.

Grazie all’ **ampia gamma** e alla possibilità di realizzare distanziali **su richiesta** specifica, con spessori diversi, a doppia foratura per elaborazione particolari e variazione di interasse, Athena diventa un partner strategico per **soddisfare tutte le esigenze del mercato**.

I distanziali Athena vengono prodotti in diverse misure che vanno dai 5 ai 50 mm.

Ogni coppia di distanziali può essere fornita completa di bulloneria certificata TUV, perfettamente intercambiabile con l’originale e compatibile con le caratteristiche dei cerchi ruota. Si consiglia di fissare la bulloneria seguendo le indicazioni della casa costruttrice e di verificarne la tenuta dopo un primo periodo di utilizzo.

ATHENA WHEEL SPACERS, QUALITY AND HIGH PERFORMANCES

Athena wheel spacers are made from a “block”, a bar of top quality aluminium, and are manufactured using CNC tooling machines to guarantee maximum precision. No welding is involved in this production process, giving the spacers unbeatable resistance and reducing the possibility of breakage to a minimum.

The choice of materials, the special design and the **TUV-certified bolts** make them the most stable and reliable on the market. The special “gloss white” colour of the Athena spacers improves the look of your vehicle, enhancing the alloy rims.

Thanks to the **wide range** and the possibility of making spacers on request, with different thicknesses, double centring for special uses and wheelbase variation, Athena becomes a strategic partner for **satisfying all market requirements**.

Athena spacers come in a wide range of measurements ranging from 5 to 50 mm.

Each pair of spacers can be supplied with TUV-certified bolts, entirely interchangeable with the OEM part and compatible with wheel rim characteristics. Athena recommend tightening the bolts following the directions of the manufacturer and checking for hold after an initial period of use.

GAMMA DISTANZIALI ATHENA

ATHENA WHEEL SPACERS RANGE



Distanziali standard con/senza bulloni
Standard wheel spacers with/without bolts



Distanziali a doppia bulloneria
Double bolts wheel spacers



Distanziali per fuoristrada
Off-road wheel spacers



Distanziali per cambio interasse
Pcd adapters



Distanziali alleggeriti
Lighter spacers
*Prodotto su richiesta / *Custom made product

CARATTERISTICHE FEATURES



1

Lega di alluminio con trattamento di anodizzazione bianca per prevenire l'ossidazione e garantire la durata nel tempo delle qualità estetiche

White anodized aluminum alloy to prevent oxidation and grant durable aesthetical properties



2

Bulloneria di alta qualità, classe 10.9 perfettamente intercambiabile con l'originale e specifica per ogni applicazione

High-end 10.9 class bolts for the specific application and entirely interchangeable with the OEM parts



3

Progettazione tecnica ad alto livello che garantisce eccellente stabilità anche in condizioni estreme

Technical design and top R&D skills to guarantee high stability in extreme conditions



4

Produzione con macchine a controllo numerico che assicurano tolleranze ad altissima precisione

CNC-machine production ensures consistent precise tolerances



5

Ampia scelta di misure, dai 5 ai 50 mm

Wide range of measurements, from 5 to 50 mm

MODALITÀ DI INSTALLAZIONE

N.B.: prima dell'installazione dei distanziali assicurarsi di aver letto attentamente le note sul prodotto in fase di acquisto. Quest'ultime sono infatti importanti per garantire un prodotto adeguato alla propria vettura. Si possono trovare nel catalogo o dal proprio rivenditore di fiducia. Si ricorda che i distanziali sono un prodotto ad uso sportivo.

Si consiglia di rivolgersi sempre a centri specializzati e personale competente per una corretta installazione.

Prima di procedere all'installazione dei distanziali, Athena consiglia di:

- Eliminare accuratamente con una spazzola metallica eventuali depositi di polvere o ruggine dai mozzi ruota.
- Verificare che la tipologia della bulloneria fornita sia identica a quella del cerchio ruota. Esempio: sede conica del bullone/dado - sede sferica del bullone/dado. Se il bullone in origine da sotto-cono/sotto-sfera misura 22 mm e si desidera installare distanziali con spessore 16 mm, il bullone fornito nel kit Athena dovrà avere una lunghezza di 38mm (cioè la somma della lunghezza del bullone originale e dello spessore del distanziale).
- L'eventuale ingombro del coperchietto paragrasso dei cuscinetti ruota dovrà essere rimosso e rimontato al centro del distanziale.
- Per vetture che montano ruote diverse dalle originali o alle quali siano state apportate modifiche all'assetto, sarà consigliabile rivolgersi a centri specializzati per verificare la possibilità del montaggio dei distanziali.

Dopo aver rispettato i dovuti accorgimenti, installare il distanziale sul mozzo ruota montando il cerchio ed avvitando i dadi o i bulloni in dotazione in senso alternato a croce (per questa operazione è consigliabile l'utilizzo di una chiave dinamometrica).

A montaggio effettuato, verificare la presenza di eventuali ingombri alle ruote affinché non vi siano interferenze con parti meccaniche o di carrozzeria.

Il servizio di assistenza tecnica Athena rimane a completa disposizione per identificare o risolvere qualsiasi problema si ponga in fase di installazione del prodotto.

ATTENZIONE

Il montaggio del distanziale altera le caratteristiche tecniche omologate della vettura. È pertanto necessario verificare che questa modifica sia consentita dal codice della strada del vostro Paese prima del montaggio.

In caso contrario, l'utilizzo sarà riservato esclusivamente in aree chiuse o in pista.

Athena declina ogni responsabilità per usi diversi.

INSTALLATION INSTRUCTIONS

N.B.: before mounting the spacers, be sure to read carefully the product notes received at time of purchase. They are important ensuring you get the right product for your vehicle. They can be found in the catalogue or at the reseller. Please remember that spacers are a product for sports use.

For perfect mounting, we recommend always using specialist centres and expert technicians.

Before mounting, Athena recommends:

- Carefully remove any dust or rust from the wheel hubs, using a wire brush
- Check that the bolts supplied are identical to those of the wheel rim. For example: tapered housing of bolt/nut - spherical housing of bolt/nut. If the original bolt measures 22 mm and you want to mount 16 mm-thick spacers, the bolt supplied in the Athena kit must be 38mm long (i.e. the sum of the length of the original bolt and the thickness of the spacer).
- Any encumbrance of the bearing retainer cover should be removed and reinstalled in the centre of the spacer.
- For vehicles with non-OEM wheels or modified wheelbase, we recommend consulting a specialist centre to check whether spacers can be mounted.

Once followed the necessary tips, mount the spacer on the wheel hub. Mount the rim and tighten the nuts or bolts supplied using a criss-cross sequence (for this operation we recommend using a torque wrench).

When mounting is complete, check that no parts of the wheel are interfering with mechanical parts or bodywork.

Our technical assistance desk is at your disposal to identify or solve any product installation problems you may encounter.

ATTENTION

By mounting spacers you are altering the approved technical features of the vehicle. So, before mounting, you should check whether this modification is permitted by your country's highway code.

If not allowed, your vehicle should only be used in enclosed areas or racetracks.

Athena declines all responsibility for other uses.



KIT DISTANZIALI PCD
CAMBIO INTERASSE ADAPTER KIT





CARATTERISTICHE E PUNTI DI FORZA

The new Athena PCD adapters range allows to install wheels with different hub diameters. The main benefits of this new product range are:



Perfect offset to improve the handling



Avoid wheel rubbing against suspension when using aftermarket wheel



Improve the look of your car

Athena wheel spacers are designed for each specific application and made from an aluminium block, with no welding points which could weaken their structure.

PCD Adapters are manufactured using CNC tooling machines to guarantee maximum precision.

PCD Adapters include top-quality 10.9 class bolts TÜV certified.

MAIN FEATURES AND KEY BENEFITS

La nuova gamma distanziali cambio interasse Athena permette di montare ruote con interasse differente al mozzo dell'auto. Questa nuova gamma di prodotti offre diversi vantaggi:



Perfetto offset per una tenuta di strada stabile e sicura



Evita lo sfregamento con le sospensioni quando si usano cerchi aftermarket



Migliora l'aspetto dell'auto

I distanziali Athena sono studiati appositamente per ogni applicazione e sono ricavati a pieno da una barra estrusa di alluminio, senza punti di fusione che ne potrebbero indebolire la struttura.

I distanziali Athena sono lavorati meccanicamente con macchine CNC a controllo numerico per garantire la massima precisione.

I kit comprendono anche bulloneria dedicata di classe 10.9 e certificata TÜV.

SCHEDA RICHIESTA DISTANZIALI SU MISURA

CUSTOM SPACER REQUEST FORM

Date/Data _____

COMPANY NAME / AZIENDA

Address / Indirizzo

CONTACT PERSON / PERSONA DI CONTATTO

Phone/Fax
Telefono/Fax

e-mail

CAR INFO

INFORMAZIONI SULL' AUTO

Make/Marchio

Model/Modello

Year/Anno

Number of holes in the wheel/Numero di fori sulla ruota

3 4 5 6

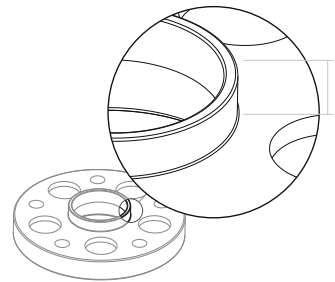

HUB Height:

Altezza mozzo:

h: _____mm

I would like to install following sizes of spacer / Voglio installare un distanziale con le seguenti dimensioni:

Front Axle thickness / Spessore distanziale asse anteriore

_____mm per side/lato

Rear Axle thickness / Spessore distanziale asse posteriore

_____mm per side/lato

Please inspect and measure the existing wheel lug bolts or studs to determine the bolt head style, size, thread diameter, shaft-length and pitch:

Si prega di misurare i bulloni o i prigionieri di serie per determinare il tipo di bullone, le dimensioni, il passo e la lunghezza del filetto.

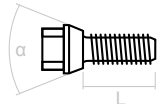

Taper Head Bolt 60°
Bullone a testa conica 60°

With loose taper
Con rondella mobile

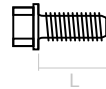

Flat Head Bolt
Bulloni piatti



Wheel Stud
Colonneta a piantaggio

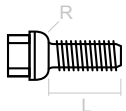

Round Head Bolt (VAG-original wheels)
Bulloni sferici

With loose round head collar
Con rondella mobile

Shaft-Length / Lunghezza della filettatura:

L: _____mm

IN CASE OF PCD ADAPTERS

IN CASO DI DISTANZIALI CAMBIO INTERASSE

Thickness (front axle) / Spessore asse anteriore

_____mm per side/lato

Thickness (rear axle) / Spessore asse posteriore

_____mm per side/lato

Are there any obstruction in the HUB? (grease cover etc.)

Esistono ingombri sul mozzo? (coperchietti paragrasso etc.)

Yes

No

	N. of holes N. di fori	C to C (mm) Interasse fori	Hub diameter (mm) Diametro mozzo
From da	_____	_____	_____
To a	_____	_____	_____

Lead time: 4 weeks / Tempo di spedizione: 4 settimane

Product made from a block, with diamond finishing / Prodotto ricavato dal pieno con finitura diamantata

Custom spacers are not refundable / I distanziali su misura non sono rimborsabili

LISTA APPLICAZIONI COMPLETA

COMPLETE LIST OF APPLICATIONS

HOW TO READ THE TABLE

- E** Thickness (mm)
Spessore (mm)
- B** Hub diameter (mm) from
Diametro mozzo (mm) da
- D** Hub diameter (mm) to
Diametro mozzo (mm) a
- A** Center to Center (mm) from
Interasse (mm) da
- C** Center to Center (mm) to
Interasse (mm) a

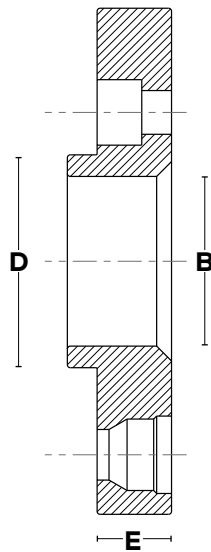

GUIDA ALLA LETTURA DELLA TABELLA

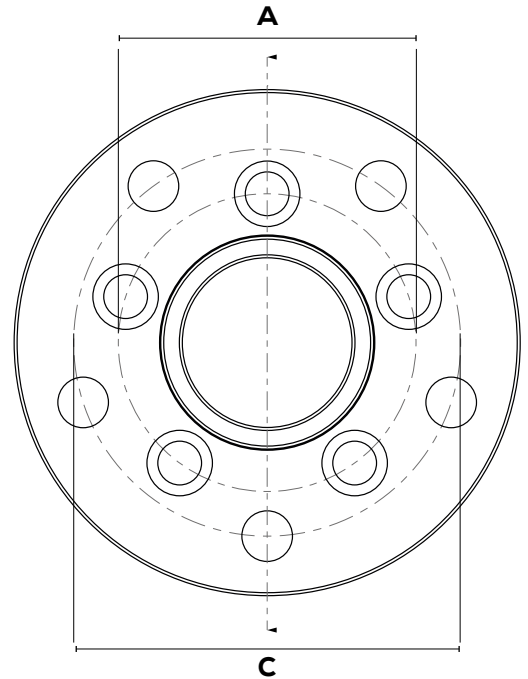

INSTALLATION NOTES

If the thickness of the wheel spacers is less than the length of the original stud bolts, the wheel spacers cannot be fitted.

Check the alloy wheels: they must be equipped with holes/lightening holes placed on the same wheel base of the wheel nuts fixing holes.

The holes/ lightening holes must have the necessary depth so that the original stud bolts of the wheel hub disappear into the wheel. On the contrary, it is absolutely necessary to shorten properly the original stud bolts fitted into the wheel hub. This kind of wheel spacers cannot be fitted into steel rims.

For perfect mounting, we recommend always using specialist centres and expert technicians.

ATTENTION

By mounting spacers you are altering the approved technical features of the vehicle. So, before mounting, you should check whether this modification is permitted by your country's highway code. If not allowed, your vehicle should only be used in enclosed areas or racetracks. Athena declines all responsibility for other uses.

NOTE DI INSTALLAZIONE

Qualora lo spessore dei distanziali fosse inferiore alla lunghezza delle colonnette originali, i distanziali non potranno essere installati.

Verificare i cerchi in lega: questi devono essere provvisti di fori/cavi di alleggerimento poste sullo stesso interasse dei fori di fissaggio dei dadi ruota. I fori/cavi devono avere la profondità necessaria affinché le colonnette originali del mozzo ruota vadano a scomparsa nei cerchi in lega. Così non fosse, è assolutamente necessario provvedere ad accorciare le colonnette originali, installate nel mozzo ruota, in modo adeguato. I distanziali di questo tipo non possono essere installati su cerchi in acciaio.

Si consiglia di rivolgersi sempre a centri specializzati e personale competente per una corretta installazione.

ATTENZIONE

Il montaggio del distanziale altera le caratteristiche tecniche omologate della vettura. È pertanto necessario verificare che questa modifica sia consentita dal codice della strada del vostro Paese prima del montaggio. In caso contrario, l'utilizzo sarà riservato esclusivamente in aree chiuse o in pista. Athena declina ogni responsabilità per usi diversi.

N. di fori N. of holes	From/Da		To/a			Spessore (mm) Thickness (mm)	Codice Part Number
	Interasse (mm) C to C (mm)	Mozzo (mm) Hub diameter (mm)	N. di fori N. of holes	Interasse (mm) C to C (mm)	Mozzo (mm) Hub diameter (mm)		
	A	B		C	D		
3	112	57,00	5	112	57,00	20	0-PDDI007-20
3	112	57,00	5	112	57,00	25	0-PDDI007-25
3	112	57,00	5	112	57,00	30	0-PDDI007-30
3	112	57,00	5	112	57,00	35	0-PDDI007-35
4	100	57,00	5	100	57,00	20	0-PDDI003-20
4	100	57,00	5	100	57,00	25	0-PDDI003-25
4	100	57,00	5	100	57,00	30	0-PDDI003-30
4	100	57,00	5	100	57,00	35	0-PDDI003-35
4	100	57,00	5	100	71,50	20	0-PDDI004-20
4	100	57,00	5	100	71,50	25	0-PDDI004-25
4	100	57,00	5	100	71,50	30	0-PDDI004-30
4	100	60,00	4	100	57,00	16	0-PDDI012-16
4	100	60,00	4	100	57,00	25	0-PDDI012-25
4	108	65,00	4	100	60,00	25	0-PDDI013-25
4	108	65,00	4	100	60,00	30	0-PDDI013-30
4	108	65,00	4	100	60,00	40	0-PDDI013-40
4	95	60,00	4	100	60,10	25	0-PDDI038-25
4	140	92,00	4	114	67,00	25	0-PDDI056-25
4	100	60,00	5	100	56,10	20	0-PDDI085-20
4	130	79,00	4	100	79,00	20	0-PDDI086-20
4	100	56,50	5	100	72,00	30	0-PDDI090-30
4	100	56,50	5	100	72,00	50	0-PDDI090-50
4	115	81,00	5	165	81,00	40	0-PDDI100-40
4	100	56,60	4	100	65,00	20	0-PDDI103-20
4	108	65,00	5	108	65,00	20	0-PDDI106-20
4	102	59,50	4	130	81,30	25	0-PDDI109-25
4	108	65,00	5	108	63,3	25	0-PDDI112-25
4	130	85,00	4	100	60,00	25	0-PDDI113-25
4	130	85,00	4	100	60,00	35	0-PDDI113-35
4	130	85,00	4	100	60,00	35	0-PDDI113-35
4	100	60,00	5	100	57,00	20	0-PDDI116-20
4	98	58,00	4	100	67,00	35	0-PDDI121-35
4	98	59,00	4	108	70,00	25	0-PDDI123-25
4	98	58,00	4	108	70,00	25	0-PDDI124-25
4	100	60,00	5	100	74,10	25	0-PDDI148-25
4	100	60,00	5	100	74,10	50	0-PDDI148-50
4	108	63,30	4	98	63,40	20	0-PDDI153-20
4	108	63,30	4	98	63,40	50	0-PDDI153-50
4	98	58,00	4	108	63,00	30	0-PDDI155-30
4	108	63,30	4	100	73,10	20	0-PDDI156-20
4	98	58,00	4	100	58,00	20	0-PDDI157-20
4	98	58,00	4	100	58,00	25	0-PDDI157-25
4	98	58,00	4	100	57,00	35	0-PDDI159-35
4	114	67,00	4	100	56,10	25	0-PDDI167-25
4	108	65,00	5	108	65,00	20	0-PDDI174-20
4	100	57,00	4	108	57,00	20	0-PDDI177-20
4	100	57,00	4	108	57,00	30	0-PDDI177-30
4	98	58,00	5	98	58,00	20	0-PDDI184-20
5	100	57,00	5	130	71,5	20	0-PDDI001-20

*DIAMOND FINISH / Finitura diamantata • Available in one week / Disponibile in una settimana

N. di fori N. of holes	From/Da		N. di fori N. of holes	To/a		Spessore (mm) Thickness (mm)	Codice Part Number
	Interasse (mm) C to C (mm)	Mozzo (mm) Hub diameter (mm)		Interasse (mm) C to C (mm)	Mozzo (mm) Hub diameter (mm)		
	A	B		C	D		
5	100	57,00	5	130	71.5	25	O-PDDI001-25
5	100	57,00	5	130	71.5	30	O-PDDI001-30
5	100	57,00	5	130	71.5	35	O-PDDI001-35
5	112	57,00	5	130	71,50	20	O-PDDI002-20
5	112	57,00	5	130	71,50	25	O-PDDI002-25
5	112	57,00	5	130	71,50	30	O-PDDI002-30
5	112	57,00	5	130	71,50	35	O-PDDI002-35
5	100	57,00	5	112	57,00	20	O-PDDI005-20
5	100	57,00	5	112	57,00	25	O-PDDI005-25
5	100	57,00	5	112	57,00	30	O-PDDI005-30
5	100	57,00	5	112	57,00	35	O-PDDI005-35
5	100	57,00	5	112	57,00	50	O-PDDI005-50
5	112	57,00	5	100	57,00	20	O-PDDI006-20
5	112	57,00	5	100	57,00	25	O-PDDI006-25
5	112	57,00	5	100	57,00	30	O-PDDI006-30
5	112	57,00	5	100	57,00	35	O-PDDI006-35
5	120	72,50	5	130	71,50	25	O-PDDI008-25
5	120	72,50	5	130	71,50	30	O-PDDI008-30
5	120	72,50	5	130	71,50	35	O-PDDI008-35
5	112	66,50	5	130	71,50	25	O-PDDI009-25
5	112	66,50	5	130	71,50	30	O-PDDI009-30
5	112	66,50	5	130	71,50	35	O-PDDI009-35
5	110	65,00	5	130	71,50	25	O-PDDI010-25
5	110	65,00	5	130	71,50	30	O-PDDI010-30
5	110	65,00	5	130	71,50	35	O-PDDI010-35
5	121	73,70	5	108	63,30	25	O-PDDI011-25
5	130	71,50	5	112	66,45	20	O-PDDI014-20
5	130	71,50	5	112	66,45	20	O-PDDI014-25
5	114	60,00	5	100	65,00	20	O-PDDI016-20
5	114	60,00	5	100	65,00	25	O-PDDI016-25
5	114	67,00	5	112	57,00	20	O-PDDI021-20
5	121	73,70	5	108	63,30	20	O-PDDI022-20
5	114	71,50	5	127	71,50	20	O-PDDI023-20
5	114	71,50	5	127	71,50	30	O-PDDI023-30
5	108	60,00	5	114	66,00	25	O-PDDI024-25
5	114	61,30	5	100	57,00	30	O-PDDI025-30
5	120	74,00	5	120	72,50	20	O-PDDI026-20
5	120	74,00	5	120	72,50	25	O-PDDI026-25
5	120	74,00	5	120	72,50	30	O-PDDI026-30
5	120	74,00	5	120	72,50	35	O-PDDI026-35
5	120	74,00	5	120	72,50	14	O-PDDI026-B-14
5	112,0	57,00	5	120,0	72,50	20	O-PDDI027-20
5	120	72,50	5	112	57,00	20	O-PDDI029-20
5	120	72,50	5	112	57,00	25	O-PDDI029-25
5	120	72,50	5	112	57,00	30	O-PDDI029-30
5	120	72,50	5	112	57,00	40	O-PDDI029-40
5	118	71,00	5	114	66,00	25	O-PDDI030-25
5	130	71,50	5	120	65,00	20	O-PDDI031-20
5	130	71,50	5	120	65,00	25	O-PDDI031-25

N. di fori N. of holes	From/Da		To/a			Spessore (mm) Thickness (mm)	Codice Part Number
	Interasse (mm) C to C (mm)	Mozzo (mm) Hub diameter (mm)	N. di fori N. of holes	Interasse (mm) C to C (mm)	Mozzo (mm) Hub diameter (mm)		
	A	B	C	D	E		
5	130	71,50	5	120	65,00	30	0-PDDI031-30
5	130	71,50	5	112	66,50	20	0-PDDI032-20
5	130	71,50	5	112	66,50	25	0-PDDI032-25
5	130	71,50	5	112	66,50	30	0-PDDI032-30
5	108	67,00	5	120	72,50	20	0-PDDI033-20
5	108	67,00	5	114	67,00	20	0-PDDI034-20
5	108	67,00	5	114	67,00	25	0-PDDI034-25
5	108	67,00	5	114	67,00	40	0-PDDI034-40
5	108	63,30	5	112	73,00	20	0-PDDI036-20
5	112	66,50	5	120	72,50	25	0-PDDI037-25
5	114	67,00	5	114	73,00	25	0-PDDI039-25
5	120	65,00	5	130	71,50	20	0-PDDI040-20
5	108,0	63,30	5	130,0	71,50	20	0-PDDI041-20
5	114	71,50	5	130	71,50	25	0-PDDI045-25
5	121	70,50	5	110	65,00	25	0-PDDI046-25
5	118	71,00	5	112	57,00	20	0-PDDI052-20
5	112	66,50	5	112	57,00	15	0-PDDI054-15
5	112	66,50	5	112	57,00	20	0-PDDI054-20
5	118	71,00	5	108	60,00	25	0-PDDI058-25
5	98	58,00	5	110	65,00	20	0-PDDI060-20
5	98	58,00	5	110	65,00	25	0-PDDI060-25
5	120	74,00	5	120	81,00	30	0-PDDI081-30
5	130	71,50	5	120	74,00	30	0-PDDI082-30
5	120	65,00	5	112	66,60	25	0-PDDI083-25
5	112	66,45	5	108	25,00	25	0-PDDI084-25
5	130	71,50	5	120	73,00	25	0-PDDI087-25
5	130	71,50	5	120	73,00	30	0-PDDI087-30
5	130	84,00	5	127	71,50	30	0-PDDI088-30
5	100	57,00	5	114	67,00	20	0-PDDI089-20
5	100	57,00	5	114	72,00	25	0-PDDI101-25
5	112	66,50	5	108	63,40	30	0-PDDI102-30
5	112	66,50	5	108	63,40	50	0-PDDI102-50
5	120	72,50	5	120	82,00	16	0-PDDI104-16
5	114	66,00	5	120	72,5	20	0-PDDI107-20
5	127	71,50	5	114	71,50	30	0-PDDI107-30
5	108	58,00	5	120	72,50	25	0-PDDI110-25
5	108	58,00	5	120	72,50	25	0-PDDI111-25
5	127	71,50	5	130	71,50	20	0-PDDI115-20
5	114,3	67,00	5	100,0	56,00	20	0-PDDI117-20
5	114	56,00	5	100	56,00	25	0-PDDI117-25
5	114	70,60	5	114	67,00	20	0-PDDI118-20
5	100	57,00	5	110	65,00	20	0-PDDI119-20
5	100	54,00	5	112	57,00	20	0-PDDI120-20
5	100	57,00	5	108	67,00	20	0-PDDI125-20
5	100	57,00	5	108	67,00	40	0-PDDI125-40
5	130	84,00	5	112	66,45	20	0-PDDI127-20
5	100	56,00	5	114	56,00	20	0-PDDI128-20
5	100	56,00	5	114	56,00	25	0-PDDI128-25
5	114	67,00	5	98	56,10	35	0-PDDI129-35

*DIAMOND FINISH / Finitura diamantata • Available in one week / Disponibile in una settimana

N. di fori N. of holes	From/Da		N. di fori N. of holes	To/a		Spessore (mm) Thickness (mm)	Codice Part Number
	Interasse (mm) C to C (mm)	Mozzo (mm) Hub diameter (mm)		Interasse (mm) C to C (mm)	Mozzo (mm) Hub diameter (mm)		
	A	B		C	D		
5	130	84,00	5	127	71,50	30	O-PDDI130-30
5	112	66,45	5	130	71,50	20	O-PDDI132-20
5	112	66,45	5	130	71,50	25	O-PDDI132-25
5	112	66,45	5	130	71,50	35	O-PDDI132-35
5	114	60,00	5	130	71,50	30	O-PDDI133-30
5	114	60,00	5	108	63,30	30	O-PDDI134-30
5	130	71,50	5	140	85,00	30	O-PDDI135-30
5	130	71,50	5	140	85,00	40	O-PDDI135-40
5	112	66,45	5	120	72,50	20	O-PDDI136-20
5	112	66,45	5	120	72,50	25	O-PDDI136-25
5	130	84,00	5	112	66,50	20	O-PDDI137-20
5	112	57,00	5	130	71,50	20	O-PDDI138-20
5	120	74,00	5	120	72,60	22	O-PDDI141-22
5	106	58,00	5	98	58,00	20	O-PDDI142-20
5	114	80,00	5	121	80,00	20	O-PDDI143-20
5	112	57,00	5	112	66,50	10	O-PDDI144-10
5	100	57,00	5	112	75,00	20	O-PDDI145-20
5	114.3	64,00	5	120	72.5	20	O-PDDI146-20
5	114.3	70,00	5	120	72.5	20	O-PDDI147-20
5	110	65,00	5	100	57,10	20	O-PDDI150-20
5	130	84,00	5	127	71,50	30	O-PDDI151-30
5	130	84,00	5	127	71,50	50	O-PDDI151-50
5	120	65,00	5	130	71,50	20	O-PDDI152-20
5	127	71,60	5	120	72,60	20	O-PDDI154-20
5	100	56,00	5	114	66,00	30	O-PDDI158-30
5	120	72,50	5	108	73,00	20	O-PDDI160-20
5	130	71,50	5	120	72,50	50	O-PDDI161-50
5	121	70,30	5	108	72,60	20	O-PDDI162-20
5	120	65,00	5	127	78,40	25	O-PDDI163-25
5	121	74,00	5	108	60,10	25	O-PDDI164-25
5	127	71,60	5	120	72,60	25	O-PDDI165-25
5	108	67,00	5	120	72,50	25	O-PDDI166-25
5	108	63,30	5	120	72,60	25	O-PDDI168-25
5	130	71,50	5	112	57,00	20	O-PDDI169-20
5	130,0	71,60	5	112,0	57,10	30	O-PDDI169-30
5	120	65,00	5	127	71,60	25	O-PDDI170-25
5	120	65,00	5	127	71,60	35	O-PDDI170-35
5	108	65,00	5	112	57,00	20	O-PDDI171-20
5	108	67,00	5	130	71,50	26	O-PDDI172-26
5	108	67,00	5	130	71,50	30	O-PDDI172-30
5	114	60,00	5	100	54,00	20	O-PDDI175-20
5	108	63,30	5	114	71,00	20	O-PDDI178-20
5	108	65,00	4	108	65,00	20	O-PDDI179-20
5	108	65,00	4	108	65,00	25	O-PDDI179-25
5	127	71,50	5	120	72,50	30	O-PDDI180-30
5	114	66,10	5	108	60,10	20	O-PDDI181-20
5	105	56,50	5	115	70,00	20	O-PDDI182-20
5	100	57,00	5	112	57,00	20	O-PDDI183-20
5	100	57,00	5	112	66,45	20	O-PDDI187-20
5	120	72,50	5	112	66,60	20	O-PDDI188-20

LISTA APPLICAZIONI DISTANZIALI CAMBIO INTERASSE

PCD ADAPTER APPLICATION GUIDELINE

Modello MAKE/model	N. di fori N. of holes	From / Da		Possibili applicazioni adattabili Possible adaption	To / a		Diametro mozzo Hub diameter (mm)	Spessore Thickness (mm)	Filetto Thread	Codice Part number
		Interasse fori C to C (mm)	Diametro mozzo Hub diameter (mm)		N. di fori N. of holes	Interasse fori C to C (mm)				

ALFA/FIAT

Alfa/Fiat	4	98	58	VW	4	100	57,1	35mm	M12x1,5	O-PDDI159-35
-----------	---	----	----	----	---	-----	------	------	---------	--------------

AUDI

Audi	5	100	57	Alfa Romeo	5	110	65	20	M14x1,5	O-PDDI119-20
				Audi/VW	5	112	57,1	20	M14x1,5	O-PDDI005-20
								25	M14x1,5	O-PDDI005-25
								30	M14x1,5	O-PDDI005-30
								35	M14x1,5	O-PDDI005-35
								50	M14x1,5	O-PDDI005-50
				Mazda/Mitsubishi	5	114,3	67,1	20	M12x1,5	O-PDDI089-20
				Porsche	5	130	71,6	20	M14x1,5	O-PDDI001-20
								25	M14x1,5	O-PDDI001-25
								30	M14x1,5	O-PDDI001-30
								35	M14x1,5	O-PDDI001-35
				Vag / Mercedes	5	112	66,45	20	M14x1,5	O-PDDI187-20
Audi	5	112	57	Audi/VW	5	100	57	20	M14x1,5	O-PDDI006-20
								25	M14x1,5	O-PDDI006-25
								30	M14x1,5	O-PDDI006-30
								35	M14x1,5	O-PDDI006-35
				BMW	5	120	72,5	20	M12x1,5	O-PDDI027-20
				Porsche	5	130	71,5	20	M14x1,5	O-PDDI002-20
								25	M14x1,5	O-PDDI002-25
								30	M14x1,5	O-PDDI002-30
								35	M14x1,5	O-PDDI002-35
Audi	5	112	66,45	Audi/VW	5	112	57,1	15	without bolts	O-PDDI054-15
								20	without bolts	O-PDDI054-20
Audi	5	112	66,45	BMW	5	120	72,5	20	M14x1,50	O-PDDI136-20
								25	M14x1,50	O-PDDI136-25
				Porsche	5	130	71,5	25	M14x1,5	O-PDDI009-25
								30	M14x1,5	O-PDDI009-30
								35	M14x1,5	O-PDDI009-35

BMW

Bmw	5	112	66,6	BMW	5	120	72,5	25	M14x1,25	O-PDDI037-25
	5	120	72,5	BMW	5	112	66,6	20	M14x1,25	O-PDDI188-20

*DIAMOND FINISH / Finitura diamantata • Available in one week / Disponibile in una settimana

Modello MAKE/model	N. di fori N. of holes	From / Da		Possibili applicazioni adattabili Possible adaption	To / a			Spessore Thickness (mm)	Filetto Thread	Codice Part number
		Interasse fori C to C (mm)	Diametro mozzo Hub diameter (mm)		N. di fori N. of holes	Interasse fori C to C (mm)	Diametro mozzo Hub diameter (mm)			

CITROËN

Citroen	4	108	65	Renault	4	100	60,1	25	M12x1,5	O-PDDI013-25
								30	M12x1,5	O-PDDI013-30
								40	M12x1,5	O-PDDI013-40
	5	108	65	Citroën/Peugeot	4	108	65	20	M12x1,25	O-PDDI179-20
								25	M12x1,25	O-PDDI179-25

FORD

Ford	5	108	63,3	Porsche	5	130	71,5	20	M14x1,5	O-PDDI041-20
				Volvo	5	114,3	71	20	M12x1,5	O-PDDI178-20

HYUNDAI

Hyundai	5	114,3	67,1	Audi/VW	5	112	57,1	20	M14x1,5	O-PDDI021-20
---------	---	-------	------	---------	---	-----	------	----	---------	--------------

JEEP

Jeep	5	127	71,5	Land Rover	5	120	72,5	30	M14x1,5	O-PDDI180-30
------	---	-----	------	------------	---	-----	------	----	---------	--------------

KIA

Kia	5	114,3	67,1	Audi/VW	5	112	57,1	20	M14x1,5	O-PDDI021-20
-----	---	-------	------	---------	---	-----	------	----	---------	--------------

MAZDA

Mazda	5	114,3	67,1	Audi/VW	5	112	57,1	20	M14x1,5	O-PDDI021-20
-------	---	-------	------	---------	---	-----	------	----	---------	--------------

MERCEDES BENZ

Mercedes M12x1,50	5	112	66,45	Ford/Volvo	5	108	63,3	30	M14x1,5	O-PDDI102-30
								50	M14x1,5	O-PDDI102-50
								20	M14x1,50	O-PDDI136-20
								25	M14x1,5	O-PDDI009-25
								35	M14x1,5	O-PDDI009-35
Mercedes M14x1,50	5	112	66,45	BMW	5	120	72,5	20	M14x1,50	O-PDDI136-20
								25	M14x1,50	O-PDDI037-25
Mercedes	5	130	84	Mercedes	5	112	66,5	20	M14x1,50	O-PDDI137-20

Modello MAKE/model	From / Da			To / a			Spessore Thickness (mm)	Filetto Thread	Codice Part number
	N. di fori N. of holes	Interasse fori C to C (mm)	Diametro mozzo Hub diameter (mm)	Possibili applicazioni adattabili Possible adaption	N. di fori N. of holes	Interasse fori C to C (mm)			

MITSUBISHI

Mitsubishi	5	114,3	67,1	Audi/VW	5	112	57,1	20	M14x1,5	O-PDDI021-20
------------	---	-------	------	---------	---	-----	------	----	---------	--------------

NISSAN

Nissan	5	114,3	66	BMW	5	120	72,5	20	M12x1,5	O-PDDI107-20
--------	---	-------	----	-----	---	-----	------	----	---------	--------------

OPEL

Opel	5	110	65	Audi/VW	5	100	57,1	20	M14x1,5	O-PDDI150-20
				Porsche	5	130	71,6	25	M14x1,5	O-PDDI010-25
								30	M14x1,5	O-PDDI010-30
								35	M14x1,5	O-PDDI010-35

PORSCHE

Porsche	5	130	71,6	Audi/VW	5	112	57,1	30	M14x1,5	O-PDDI169-30
---------	---	-----	------	---------	---	-----	------	----	---------	--------------

RENAULT

Renault	5	108	60,1	Renault	5	114,3	66	25	M14x1,5	O-PDDI024-25
---------	---	-----	------	---------	---	-------	----	----	---------	--------------

SEAT

Seat	4	100	57,1	Audi/VW	5	100	57,1	20	M12x1,5	O-PDDI003-20
								25	M12x1,5	O-PDDI003-25
								30	M12x1,5	O-PDDI003-30
								35	M12x1,5	O-PDDI003-35
Seat	5	100	57,1	Alfa	5	110	65	20	M14x1,5	O-PDDI119-20
				Audi/VW	5	112	57,1	20	M14x1,5	O-PDDI005-20
								25	M14x1,5	O-PDDI005-25
								30	M14x1,5	O-PDDI005-30
Seat	5	112	57,1	Mercedes	5	112	66,5	20	Without bolts	O-PDDI144-20

SKODA

Skoda	4	100	57,1	Audi/VW	5	100	57,1	20	M12x1,5	O-PDDI003-20
								25	M12x1,5	O-PDDI003-25
								30	M12x1,5	O-PDDI003-30
								35	M12x1,5	O-PDDI003-35

Modello MAKE/model	From / Da			To / a				Spessore Thickness (mm)	Filetto Thread	Codice Part number
	N. di fori N. of holes	Interasse fori C to C (mm)	Diametro mozzo Hub diameter (mm)	Possibili applicazioni adattabili Possible adaption	N. di fori N. of holes	Interasse fori C to C (mm)	Diametro mozzo Hub diameter (mm)			
Skoda	5	100	57,1	Alfa	5	110	65	20	M12x1,5	0-PDDI119-20
				Audi/VW	5	112	57,1	20	M14x1,5	0-PDDI005-20
								25	M14x1,5	0-PDDI005-25
								30	M14x1,5	0-PDDI005-30
								35	M14x1,5	0-PDDI005-35
				Mazda/Mitshubishi	5	114,3	67,1	20	M14x1,5	0-PDDI089-20
				Kia/Hyundai						
				Porsche	5	130	71,6	20	M14x1,5	0-PDDI001-20
								25	M14x1,5	0-PDDI001-25
								30	M14x1,5	0-PDDI001-30
								35	M14x1,5	0-PDDI001-35
Skoda	5	112	57,1	Audi/VW	5	100	57	20	M14x1,5	0-PDDI006-20
								25	M14x1,5	0-PDDI006-25
								30	M14x1,5	0-PDDI006-30
								35	M14x1,5	0-PDDI006-35
				Mercedes	5	112	66,5	20	Without bolts	0-PDDI144-20
				BMW	5	120	72,5	20	M12x1,5	0-PDDI027-20

TOYOTA

Toyota	5	114,3	60,1	Porsche	5	130	71,6	25	M14x1,50	0-PDDI133-30
--------	---	-------	------	----------------	---	-----	------	----	----------	--------------

VOLKSWAGEN

VW	4	100	57,1	Audi/VW	5	100	57,1	20	M12x1,5	0-PDDI003-20
								25	M12x1,5	0-PDDI003-25
								30	M12x1,5	0-PDDI003-30
								35	M12x1,5	0-PDDI003-35
VW	5	100	57,1	Audi/VW	5	112	57,1	20	M14x1,5	0-PDDI005-20
								25	M14x1,5	0-PDDI005-25
								30	M14x1,5	0-PDDI005-30
								35	M14x1,5	0-PDDI005-35
								50	M14x1,5	0-PDDI005-50
VW	5	112	57,1	Mercedes	5	112	66,5	20	Without bolts	0-PDDI144-20
				BMW	5	120	72,5	20	M12x1,5	0-PDDI027-20
				Porsche	5	130	71,5	20	M14x1,5	0-PDDI002-20
								25	M14x1,5	0-PDDI002-25
								30	M14x1,5	0-PDDI002-30
								35	M14x1,5	0-PDDI002-35
T5/Touareg	5	120	65	Touareg	5	130	71,6	20	M14x1,5	0-PDDI040-20
Touareg	5	130	71,6	T5/Touareg	5	120	65,0	20	M14x1,5	0-PDDI031-20
								25	M14x1,5	0-PDDI031-25
								35	M14x1,5	0-PDDI031-30

APPLICAZIONI WHEEL SPACER
DISTANZIALI APPLICATION

ABARTH

MODELLO / MODEL	ANNO / YEAR DA / START A / END	NOTA CHIAVE KEY NOTE	SPESSORE THICKNESS (mm)	TIPO TYPE	INTERASSE C TO C	Ø	FILETTO THREAD	CODICE CODE #	NOTE NOTES
500 Type 312	Sept/2008	>	5	M1	4x98	58		0-P0510S	A-Y
			5	M2a	4x98	58	M12x1,25	0-P0510C7	B-Y
			5	M2a	4x98	58	M12x1,25	0-P05105C	C-Y
			12	M1	4x98	58		0-P1210S	
			12	M2a	4x98	58	M12x1,25	0-P1210C7	B
			12	M2a	4x98	58	M12x1,25	0-P12105C	C
			16	M1	4x98	58		0-P1610S	
			16	M2a	4x98	58	M12x1,25	0-P1610C7	B
			16	M2a	4x98	58	M12x1,25	0-P16105C	C
			20	M1	4x98	58		0-P2010S	
			20	M2a	4x98	58	M12x1,25	0-P2010C7	B
			20	M2a	4x98	58	M12x1,25	0-P20105C	C
			25	M5	4x98	58	M12x1,25	0-P2510CD	
			30	M5	4x98	58	M12x1,25	0-P3010CD	
			35	M5	4x98	58	M12x1,25	0-P3510CD	
			40	M5	4x98	58	M12x1,25	0-P4010CD	
			45	M5	4x98	58	M12x1,25	0-P4510CD	
50	M5	4x98	58	M12x1,25	0-P5010CD				
Grande Punto Type 199 Punto EVO Type 199	Oct/2005 Oct/2009	Sept/2009 Feb/2012	5	M1	4x100	56,5		0-P0517S	A-Y
			5	M2a	4x100	56,5	M12x1,50	0-P0517C	B-Y
			5	M2a	4x100	56,5	M12x1,50	0-P05106C	C-Y
			17	M1	4x100	56,5		0-P1717S	
			17	M2a	4x100	56,5	M12x1,50	0-P1717C	B
			17	M2a	4x100	56,5	M12x1,50	0-P17106C	C
			20	M1	4x100	56,5		0-P2017S	
			20	M2a	4x100	56,5	M12x1,50	0-P2017C	B
			20	M2a	4x100	56,5	M12x1,50	0-P20106C	C
			25	M5	4x100	56,5	M12x1,50	0-P2517CD	
			30	M5	4x100	56,5	M12x1,50	0-P3017CD	
			35	M5	4x100	56,5	M12x1,50	0-P3517CD	
			40	M5	4x100	56,5	M12x1,50	0-P4017CD	
124 Spider Abarth Type 348	2016	>	20	M4	4X100	54	M12X1,50	0-P2014CD	M

ALFA ROMEO

MODELLO / MODEL	ANNO / YEAR DA / START A / END	NOTA CHIAVE KEY NOTE	SPESSORE THICKNESS (mm)	TIPO TYPE	INTERASSE C TO C	Ø	FILETTO THREAD	CODICE CODE #	NOTE NOTES
145 Type 930 146 Type 930 155 Type 167 164 Type 164 164 2.0 Twin Spark	1994 1994 1992 1987 1987	2001 2001 1997 1997 1997	5	M1	4X98	58		0-P0510S	A-Y
			5	M2a	4X98	58	M12X1,25	0-P0510C	Y
			12	M1	4X98	58		0-P1210S	
			12	M2a	4X98	58	M12X1,25	0-P1210C	
			16	M1	4X98	58		0-P1610S	
			16	M2a	4X98	58	M12X1,25	0-P1610C	
			20	M1	4X98	58		0-P2010S	
			20	M2a	4X98	58	M12X1,25	0-P2010C	
			25	M5	4X98	58	M12X1,25	0-P2510CD	
			30	M5	4X98	58	M12X1,25	0-P3010CD	
			35	M5	4X98	58	M12X1,25	0-P3510CD	
			40	M5	4X98	58	M12X1,25	0-P4010CD	
			45	M5	4X98	58	M12X1,25	0-P4510CD	
			50	M5	4X98	58	M12X1,25	0-P5010CD	
156 Type 932 164 Type 164 6 cyl.	1997 1987	1999 1997	5	M1	5X98	58		0-P0504S	A-Y
			5	M2a	5X98	58	M12X1,25	0-P0504C	Y
			12	M1	5X98	58		0-P1204S	
			12	M2a	5X98	58	M12X1,25	0-P1204C	
			16	M1	5X98	58		0-P1604S	
			16	M2a	5X98	58	M12X1,25	0-P1604C	
			20	M1	5X98	58		0-P2004S	
			20	M2a	5X98	58	M12X1,25	0-P2004C	
			25	M5	5X98	58	M12X1,25	0-P2504CD	
			30	M5	5X98	58	M12X1,25	0-P3004CD	
			35	M5	5X98	58	M12X1,25	0-PN3504CD*	
			40	M5	5X98	58	M12X1,25	0-PN4004CD*	
			45	M5	5X98	58	M12X1,25	0-PN4504CD*	
			50	M5	5X98	58	M12X1,25	0-PN50004CD*	
GTV Type 916C Spider Type 916S	1995 Apr/1994	2001 Jan/1999	5	M1	5X98	58		0-P0504S	A-Y
			5	M2a	5X98	58	M12X1,25	0-P05107C	Y
			12	M1	5X98	58		0-P1204S	
			12	M2a	5X98	58	M12X1,25	0-P12107C	
			16	M1	5X98	58		0-P1604S	
			16	M2a	5X98	58	M12X1,25	0-P16107C	
			20	M1	5X98	58		0-P2004S	
			20	M2a	5X98	58	M12X1,25	0-P20107C	
			25	M5	5X98	58	M12X1,25	0-P2504CD	
			30	M5	5X98	58	M12X1,25	0-P3004CD	
			35	M5	5X98	58	M12X1,25	0-PN3504CD*	
			40	M5	5X98	58	M12X1,25	0-PN4004CD*	
			45	M5	5X98	58	M12X1,25	0-PN4504CD*	
			50	M5	5X98	58	M12X1,25	0-PN50004CD*	

*DIAMOND FINISH / Finitura diamantata • Available in one week / Disponibile in una settimana

ALFA ROMEO

MODELLO / MODEL	ANNO / YEAR DA / START A / END	NOTA CHIAVE KEY NOTE	SPESSORE THICKNESS (mm)	TIPO TYPE	INTERASSE C TO C	Ø	FILETTO THREAD	CODICE CODE #	NOTE NOTES
4 C Type 960 147 Type 937 147 GTA Type 937 156 Type 932 B1778/GTA GT Type 937 GTV Type 916 Spider Type 916S	2013 2000 2003 2000 Nov/2003 2001 Feb/2001	> Mar/2010 Mar/2010 2005 Sept/2010 2006 May/2006	5	M1	5X98	58		0-P0504S	A-Y
			5	M2a	5X98	58	M12X1,25	0-P0504C7	B-Y
			5	M2a	5X98	58	M12X1,25	0-P05108C	C-Y
			12	M1	5X98	58		0-P1204S	
			12	M2a	5X98	58	M12X1,25	0-P1204C7	B
			12	M2a	5X98	58	M12X1,25	0-P12108C	C
			16	M1	5X98	58		0-P1604S	
			16	M2a	5X98	58	M12X1,25	0-P1604C7	B
			16	M2a	5X98	58	M12X1,25	0-P16108C	C
			20	M1	5X98	58		0-P2004S	
			20	M2a	5X98	58	M12X1,25	0-P2004C7	B
			20	M2a	5X98	58	M12X1,25	0-P20108C	C
			25	M5	5X98	58	M12X1,25	0-P2504CD	
			30	M5	5X98	58	M12X1,25	0-P3004CD	
			35	M5	5X98	58	M12X1,25	0-PN3504CD*	
			40	M5	5X98	58	M12X1,25	0-PN4004CD*	
			45	M5	5X98	58	M12X1,25	0-PN4504CD*	
50	M5	5X98	58	M12X1,25	0-PN50004CD*				
Giulia Type 952 Stelvio Type 949 159 Type 939 Brera Type 939 Spider Type 939	Apr/2016 Nov/2016 Sept/2005 Jan/2006 Sept/2006	> > Nov/2011 June/2012 June/2012	5	M1	5x110	65		0-P0540S	A-Y
			5	M2a	5x110	65	M14X1,50	0-P0584C	Y
			15	M1	5x110	65		0-PN1540S*	
			15	M1	5x110	65	M14X1,50	0-PN1584C*	
			17	M1	5x110	65		0-P1740S	
			17	M2a	5x110	65	M14X1,50	0-P1784C	
			20	M1	5x110	65		0-P2040S	
			20	M2a	5x110	65	M14X1,50	0-P2084C	
30	M1	5x110	65	M14X1,50	0-PN3084CD*				
Giulietta Type 940	Apr/2010	>	5	M1	5x110	65		0-P0540S	A-Y
			5	M2a	5x110	65	M12X1,25	0-P05101C	B-Y
			5	M2a	5x110	65	M12X1,25	0-P05109C	C-Y
			17	M1	5x110	65		0-P1740S	
			17	M2a	5x110	65	M12X1,25	0-P17101C	B
			17	M2a	5x110	65	M12X1,25	0-P17109C	C
			20	M1	5x110	65		0-P2040S	
			20	M2a	5x110	65	M12X1,25	0-P20101C	B
			20	M2a	5x110	65	M12X1,25	0-P20109C	C
			20	M5	5X110	65	M12X1,25	0-PN2042CD*	
			25	M5	5X110	65	M12X1,25	0-PN2542CD*	
			30	M5	5X110	65	M12X1,25	0-PN3042CD*	
40	M5	5X110	65	M12X1,25	0-PN4042CD*				

ALFA ROMEO

MODELLO / MODEL	ANNO / YEAR DA / START A / END	NOTA CHIAVE KEY NOTE	SPESSORE THICKNESS (mm)	TIPO TYPE	INTERASSE C TO C	Ø	FILETTO THREAD	CODICE CODE #	NOTE NOTES
MiTo Type 955	2007	>	5	M1	4X98	58		0-P0510S	A-Y
			5	M2a	4X98	58	M12X1,25	0-P0510C7	B-Y
			5	M2a	4X98	58	M12X1,25	0-P05105C	C-Y
			12	M1	4X98	58		0-P1210S	
			12	M2a	4X98	58	M12X1,25	0-P1210C7	B
			12	M2a	4X98	58	M12X1,25	0-P12105C	C
			16	M1	4X98	58		0-P1610S	
			16	M2a	4X98	58	M12X1,25	0-P1610C7	B
			16	M2a	4X98	58	M12X1,25	0-P16105C	C
			20	M1	4X98	58		0-P2010S	
			20	M2a	4X98	58	M12X1,25	0-P2010C7	B
			20	M2a	4X98	58	M12X1,25	0-P20105C	C
			25	M5	4X98	58	M12X1,25	0-P2510CD	
			30	M5	4X98	58	M12X1,25	0-P3010CD	
			35	M5	4X98	58	M12X1,25	0-P3510CD	
			40	M5	4X98	58	M12X1,25	0-P4010CD	
45	M5	4X98	58	M12X1,25	0-P4510CD				
50	M5	4X98	58	M12X1,25	0-P5010CD				
166 Type 939	1998	2007	12	M1	5x108	58		0-P1202S	
			12	M2a	5x108	58	M12X1,25	0-P1202C	
			12	M2a	5x108	58	M12X1,25	0-P12110C	
			16	M1	5x108	58		0-P1602S	
			16	M2a	5x108	58	M12X1,25	0-P1602C	B
			16	M2a	5x108	58	M12X1,25	0-P16110C	C
			20	M1	5x108	58		0-P2002S	
			20	M2a	5x108	58	M12X1,25	0-P2002C	B
			20	M2a	5x108	58	M12X1,25	0-P20110C	C
ALFA 75 Type 162B (6 Cyl) ALFA 90 Type 162 (6 Cyl)	1985 1984	1992 1987	16	M1	5x98	58,5		0-PN1605S*	
			20	M1	5x98	58,5		0-PN2005S*	
			20	M4	5x98	58,5	M12x1,50	0-PN2005CD*	M
			25	M4	5x98	58,5	M12x1,50	0-PN2505CD*	M
			30	M4	5x98	58,5	M12x1,50	0-PN3005CD*	M
			35	M4	5x98	58,5	M12x1,50	0-PN3505CD*	M
			40	M4	5x98	58,5	M12x1,50	0-PN4005CD*	M
ALFA 75 Type 162B (4 Cyl.) 90 Type 162 (4 Cyl) Gtv Type 116	1985 1984 1978	1992 1987 1987	16	M1	4x98	58,5		0-PN1601S*	
			20	M4	4x98	58,5	M12x1,50	0-PN2001CD*	M
			30	M4	4x98	58,5	M12x1,50	0-PN3001CD*	M
			35	M4	4x98	58,5	M12x1,50	0-PN3501CD*	M
			50	M4	4x98	58,5	M12x1,50	0-PN5001CD*	NEW

*DIAMOND FINISH / Finitura diamantata • Available in one week / Disponibile in una settimana

AUDI

MODELLO / MODEL	ANNO / YEAR DA / START A / END	NOTA CHIAVE KEY NOTE	SPESSORE THICKNESS (mm)	TIPO TYPE	INTERASSE C TO C	Ø	FILETTO THREAD	CODICE CODE #	NOTE NOTES
A1 Type 8X A1 Type GB S1 Type 8X A2 Type 8Z0 A3 Type 8L S3 Type 8L TT I Type 8N TT I Cabrio Type 8N TT I Quattro Type 8N	May/2010 2018 2014 Feb/2000 Sept/1996 1998 Oct/1998 Oct/1998 Oct/1998	2018 > > Aug/2005 Apr/2003 2003 July/2006 July/2006 July/2006	5	M1	5x100	57		O-P0527S	A-Y
			5	M3a	5x100	57	M14x1,50	O-P0527CS	B-Y
			5	M2a	5x100	57	M14x1,50	O-P0527C	C-Y
			10	M1	5x100	57		O-PN10270ES*	Z
			12	M1	5x100	57		O-P1227S	
			12	M3a	5x100	57	M14x1,50	O-P1227CS	B
			12	M2a	5x100	57	M14x1,50	O-P1227C	C
			16	M1	5x100	57		O-P1627S	
			16	M3a	5x100	57	M14x1,50	O-P1627CS	B
			16	M2a	5x100	57	M14x1,50	O-P1627C	C
			20	M1	5x100	57		O-P2027S	
			20	M3a	5x100	57	M14x1,50	O-P2027CS	B
			20	M2a	5x100	57	M14x1,50	O-P2027C	C
			20	M5	5x100	57	M14x1,50	O-PN2027CD*	
			25	M5	5x100	57	M14x1,50	O-P2527CD	
			30	M5	5x100	57	M14x1,50	O-P3027CD	
			35	M5	5x100	57	M14x1,50	O-P3527CD	
40	M5	5x100	57	M14x1,50	O-P4027CD				
100 Type C4 200 Type 44 - 44Q A3 / Sportback / S3 Type 8V / 8VA A3 Type 8YA S3 Type 8YA A3 Type 8P 04-2003> A3 / Sportback / S3 Type 8P1 / 8PA / 8P7 A4 / S4 Type 8D (B5) A4 Type 8E (B6) / S4 Type 8E (B6) A4 Type 8E (B7) / S4 Type 8E (B7) A6 Type C4 / S6 Type C4 A6 Type C5 (4B) / Allroad Type C5 (4B) A6 Type C6 (4F) / Allroad Type C6 (4F) A8 D2 Type (4D) / S8 D2 Type (4D) A8 D3 Type (4E) / S8 D3 Type (4E) Q2 Type GA Q3 Type 8U Q3 RS Type 8U - 8U1 Q3 Type F3 RS Q3 Type F3 RS Q3 Sportback Type F3N RS3 Type 8P / 8PA RS3 Type 8V RS4 B5 Type 8D RS4 B7 Type QB6 RS6 I C5 Type 4B RS6 II C6 Type 4F S2 Type 89Q R8 Type 42 / R8 Quattro Type 42 S6 Type C4 S6 Type 4B S6 Type 4F S8 D2 Type 4D TT Coupé Type 8J TTS Coupé Type 8J TTS Roadster Type 8J TT Type 8S / 8J TT Type 8S TT RS Type 8JTTRS Urquattro Type 8S V8 Type C4 (D11)	1990 1983 Sept/2012 2020 2020 Apr/2003 Sept/2004 1996 2001 2004 1994 1997 2004 1994 2002 2016 2011 2013 2018 2019 2019 2011 2015 1999 2005 2003 2008 1990 Aug/2007 1994 1997 2005 1996 July/2006 June/2008 June/2008 2015 2015 2017 1980 1988	1996 1991 2020 > > Sept/2012 Aug/2012 2001 2003 2007 1997 2004 2011 2002 2010 > 2018 2015 > > > > 2001 2009 2007 2010 1995 2016 1997 2004 2010 2002 Dec/2014 Dec/2014 Dec/2014 > > > 1991 1994	5 5 5 12 12 10 13 16 16 20 20 20 25 30 35 40 50	M1 M2a M3a M1 M2a M3a M1 M1 M1 M2a M3a M1 M5 M5 M5 M5 M5	5x112 5x112 5x112 5x112 5x112 5x112 5x112 5x112 5x112 5x112 5x112 5x112 5x112 5x112 5x112 5x112 5x112	57 57 57 57 57 57 57 57 57 57 57 57 57 57 57 57 57		O-P0506S O-P0506C O-P0506CS O-P1206S O-P1206C O-P1206CS O-P10060ES O-P13060ES O-P1606S O-P1606C O-P1606CS O-P2006S O-P2006C O-P2006CS O-PN2006CD* O-P2506CD O-P3006CD O-P3506CD O-P4006CD O-PN5006CD*	A-Y C-Y B-Y C B Z Z C B C B C B C C B C C C C C C

*DIAMOND FINISH / Finitura diamantata • Available in one week / Disponibile in una settimana

AUDI

MODELLO / MODEL	ANNO / YEAR DA / START A / END	NOTA CHIAVE KEY NOTE	SPESSORE THICKNESS (mm)	TIPO TYPE	INTERASSE C TO C	Ø	FILETTO THREAD	CODICE CODE #	NOTE NOTES	
				5	M1	5x112	66,45		0-P0516S	A-Y
				5	M2a	5x112	66,45	M14x1,50	0-P0524C	C-Y
				5	M3a	5x112	66,45	M14x1,50	0-P05111CS	B-Y
A4 (B8) Type 8K	Nov/2007	2015		12	M1	5x112	66,45		0-P1216S	
A4 (B8) Allroad Type 8K	June/2009	2016		12	M2a	5x112	66,45	M14x1,50	0-P1224C	C
A4 (B8) Type 8K - S4 (B8) Type 8K	Mar/2009	2015		12	M3a	5x112	66,45	M14x1,50	0-P12111CS	B
A4 (B9) Allroad Type 8K	2016	>		16	M1	5x112	66,45		0-P1616S	
A4 (B9) Type B9-8W-F4	2015	>		16	M2a	5x112	66,45	M14x1,50	0-P1624C	C
S4 (B9) Type B9-8W-F4	2015	>		16	M3a	5x112	66,45	M14x1,50	0-P16111CS	B
A5 Type B8 - B81	June/2007	2017		20	M1	5x112	66,45		0-P2016S	
S5 Type B8 - B81	June/2007	2017		20	M2a	5x112	66,45	M14x1,50	0-P2024C	C
A5 Type B8 - B81	2009	2017		20	M3a	5x112	66,45	M14x1,50	0-P20111CS	B
S5 Sportback Type B8 - B81	2009	2017		20	M5	5x112	66,45	M14x1,50	0-PN2024CD*	
A5-S5 Sportback Type B8-F5-F5A-F53	2017	>		25	M5	5x112	66,45	M14x1,50	0-P2524CD	
A6 (C7) Type 4G - S6 (C7) Type 4G	Feb/2011	>		30	M5	5x112	66,45	M14x1,50	0-P3024CD	
A6 (C8) Type F2	2018	>		35	M5	5x112	66,45	M14x1,50	0-PN3524CD*	
S6 (C8) Type F2	2018	>		40	M5	5x112	66,45	M14x1,50	0-PN4024CD*	
A6 Allroad	July/2012	>		45	M5	5x112	66,45	M14x1,50	0-PN4524CD*	
A7 Sportback Type 4G	Oct/2010	2017		50	M5	5x112	66,45	M14x1,50	0-PN5024CD*	
A7 Sportback Type 4KA (F2)	2018	>		55	M5	5x112	66,45	M14x1,50	0-PN5524CD*	
S7 Sportback Type 4G / 4G1	Aug/2012	2017		60	M5	5x112	66,45	M14x1,50	0-PN6024CD*	
A8 Type 4H (D4)	Mar/2010	2017		70	M5	5x112	66,45	M14x1,50	0-PN7024CD*	
A8 (D5) Type 4N	2018	>		80	M5	5x112	66,45	M14x1,50	0-PN8024CD*	
S8 (D4) Type 4H -S8	Aug/2012	2017								
S8 (D4) Plus Type 4H	2015	>								
Q5 Type 8R / 8R1	Nov/2008	2017								
Q5 Type FY	2017	>								
RS4 (B8)Type B8	2012	2015								
RS4 (B8)Type B9	2017	>								
RS5 Type B8	Jan/2010	>								
RS6 (C7) Type 4G	2013	2018								

AUDI (Off-road)

				5	M1	5X130	71,5		0-P0537S	H
				5	M3a	5X130	71,5	M14x1,50	0-P0537CS	N-H
				8	M1	5X130	71,5		0-PN0837S* NEW	H
				10	M1	5X130	71,5		0-PN1037S* NEW	H
				12	M1	5X130	71,5		0-P1237S	
Q7 Type 4L / 4L1	Mar/2006	2015	14	12	M3a	5X130	71,5	M14x1,50	0-P1237CS	N
				16	M1	5X130	71,5		0-P1637S	
				16	M3a	5X130	71,5	M14x1,50	0-P1637CS	N
				20	M1	5X130	71,5		0-P2037S	
				20	M3a	5X130	71,5	M14x1,50	0-P2037CS	N
				25	M5	5X130	71,5	M14x1,50	0-P2592CD	
				30	M5	5X130	71,5	M14x1,50	0-P3092CD	

BENTLEY

MODELLO / MODEL	ANNO / YEAR DA / START A / END	NOTA CHIAVE KEY NOTE	SPESSORE THICKNESS (mm)	TIPO TYPE	INTERASSE C TO C	Ø	FILETTO THREAD	CODICE CODE #	NOTE NOTES
Continental GT Type 3W Continental GT Flying Spur Type 3W MTM Coupé Type 3W	2004 2005 2005	2011 2018 2011	5	M1	5x112	57		0-P0506S	A-Y
			5	M2a	5x112	57	M14x1,50	0-P0506C	C-Y
			5	M3a	5x112	57	M14x1,50	0-P0506CS	B-Y
			12	M1	5x112	57		0-P1206S	
			12	M2a	5x112	57	M14x1,50	0-P1206C	C
			12	M3a	5x112	57	M14x1,50	0-P1206CS	B
			16	M1	5x112	57		0-P1606S	
			16	M2a	5x112	57	M14x1,50	0-P1606C	C
			16	M3a	5x112	57	M14x1,50	0-P1606CS	B
			20	M1	5x112	57		0-P2006S	
			20	M2a	5x112	57	M14x1,50	0-P2006C	C
			20	M3a	5x112	57	M14x1,50	0-P2006CS	B
			25	M5	5x112	57	M14x1,50	0-P2506CD	
			30	M5	5x112	57	M14x1,50	0-P3006CD	
			35	M5	5x112	57	M14x1,50	0-P3506CD	
			40	M5	5x112	57	M14x1,50	0-P4006CD	

BMW

MODELLO / MODEL	ANNO / YEAR DA / START A / END	NOTA CHIAVE KEY NOTE	SPESSORE THICKNESS (mm)	TIPO TYPE	INTERASSE C TO C	Ø	FILETTO THREAD	CODICE CODE #	NOTE NOTES	
3 Type E21 3 Type E30 315 Type E21 323i Type E21 1502 Tii Type E10 2002 Tii Type E10 2002 Turbo Type E10 Z1 Type Z/B	1975 1982 June/1975 June/1975 Oct/1962 May/1968 Oct/1968 June/1988	1983 1994 Mar/1984 Mar/1984 Nov/1972 Apr/1977 Apr/1977 June/1991	5	M1	4X100	57		0-P0526S	A-Y	
			5	M2a	4X100	57	M12x1,50		0-P0526C	Y
			12	M1	4X100	57			0-P1226S	
			12	M2a	4X100	57	M12x1,50		0-P1226C	
			17	M1	4X100	57			0-P1726S	
			17	M2a	4X100	57	M12x1,50		0-P1726C	
			20	M1	4X100	57			0-P2026S	
			20	M2a	4X100	57	M12x1,50		0-P2026C	
			25	M5	4X100	57	M12x1,50		0-P2526CD	
			30	M5	4X100	57	M12x1,50		0-P3026CD	
			35	M5	4X100	57	M12x1,50		0-P3526CD	
			40	M5	4X100	57	M12x1,50		0-P4026CD	
			45	M5	4X100	57	M12x1,50		0-P4526CD	
			50	M5	4X100	57	M12x1,50		0-P5026CD	
Serie 1 Coupé E81 Serie 1 E87 Serie 1 E81 / E88 Serie 3 E36 Serie 3 E46 Serie 3 E90 Serie 3 Touring E91 Serie 3 Coupé E92 Serie 3 Cabriolet E93 M3 Serie E30 M3 Serie E36 M3 E46 M346 M3 E90 - E92 - E93 / M390 Serie 5 5/H E34 M5 E34 M5 E60 M560 Serie 5 E60 Serie 5 Touring E61 Serie 6 E63 Serie 6 E64 M6 E63 M6 E64 Serie 7 E23 Serie 7 E32 Serie 7 E38 Serie 8 E31 M1 Type E26 X1 Type E84 / X1 Z3 E36 Z4 E85 / Z85 Z4 E89 / Z89 / ZR Z8 E52	Sept/2004 Nov/2003 2004 Sept/1990 Feb/1998 Jan/2005 Sept/2005 June/2006 Aug/2006 July/1986 Oct/1992 2000 Mar/2007 Dec/1987 Sept/1994 Sept/2004 Mar/2003 June/2004 Jan/2004 Apr/2004 Sept/2005 July/2006 May/1977 1987 1995 1988 May/1979 Jan/2010 Oct/1995 Feb/2003 2009 June/2000	Sept/2012 Sept/2012 2011 Aug/2000 Apr/2005 2011 2011 2011 Jan/1992 Apr/1999 2006 Dec/2011 Jan/1997 Jan/1997 Oct/2009 2010 Dec/2009 2010 2010 2010 Aug/1986 1994 2001 1999 May/1983 2015 June/2003 2006 2011 June/2003	5	M1	5X120	72,5			0-P0507S	A-Y
			5	M2a	5X120	72,5	M12x1,50		0-P0507C	Y
			12	M1	5X120	72,5			0-P1207S	
			12	M2a	5X120	72,5	M12x1,50		0-P1207C	
			16	M1	5X120	72,5			0-P1607S	
			16	M2a	5X120	72,5	M12x1,50		0-P1607C	
			20	M1	5X120	72,5			0-P2007S	
			20	M2a	5X120	72,5	M12x1,50		0-P2007C	
			20	M5	5X120	72,5	M12x1,50		0-PN2007CD*	
			25	M5	5X120	72,5	M12x1,50		0-P2507CD	
			30	M5	5X120	72,5	M12x1,50		0-P3007CD	
			35	M5	5X120	72,5	M12x1,50		0-PN3507CD*	
			40	M5	5X120	72,5	M12x1,50		0-PN4007CD*	
			45	M5	5X120	72,5	M12x1,50		0-PN4507CD*	
			50	M5	5X120	72,5	M12x1,50		0-PN5007CD*	
			55	M5	5X120	72,5	M12x1,50		0-PN5507CD*	
			60	M5	5X120	72,5	M12x1,50		0-PN6007CD*	
			65	M5	5X120	72,5	M12x1,50		0-PN6507CDP*	
			70	M5	5X120	72,5	M12x1,50		0-PN7007CD*	
			75	M5	5X120	72,5	M12x1,50		0-PN7507CD*	
			80	M5	5X120	72,5	M12x1,50		0-PN8007CD*	
			95	M5	5X120	72,5	M12x1,50		0-PN9507CD*	
			100	M5	5X120	72,5	M12x1,50		0-PN10007CD*	

MODELLO / MODEL	ANNO / YEAR DA / START	A / END	NOTA CHIAVE KEY NOTE	SPESSORE THICKNESS (mm)	TIPO TYPE	INTERASSE C TO C	Ø	FILETTO THREAD	CODICE CODE #	NOTE NOTES
1 ER Type F1H-F40	2019	>								
2 ER Active Tourer Type F45-UKL-L	2014	2017		5	M1	5X112	66,45		O-P0516S	A-Y
2 ER Active Tourer Type F45-F46-F2GT	2017	2020		5	M2a	5X112	66,45	M14X1,25	O-P0543C	Y
2 ER Coupé Type F44	2019	>								
2 ER Grand Tourer Type F46-UKL-L	2015	>								
3 Type G20	2019	>								
3 ER Touring Type G21	2019	>								
4 Type G22 - G23	2021	>								
5 ER Type G30-G31-G5L-G5K	2017	>								
6 ER Gran Turismo Type G32-G6GT	2017	>								
7 ER Type G11-G12-7L	2015	>		12	M1	5X112	66,45		O-P1216S	
8 ER Type G14-G15-G16	2018	>								
i3 Type i01	2013	>								
iX3 Type G08	2020	>		12	M2a	5X112	66,45	M14X1,25	O-P1243C	
M3 Type G80	2021	>								
M4 Type G82	2021	>								
M5 Type F90-F5ML	2017>	>		16	M1	5X112	66,45		O-P1616S	
i8 Type i12	2013	>								
X1 Type F48 - UKL-L	2015	2017								
X1 Type F48 - F1X	2017	>		16	M2a	5X112	66,45	M14X1,25	O-P1643C	
X2 Type F39	2018	>								
X3 Type G01-G3X	2017	>								
X3 M Type G3X-F34XM-F97	2019	>		20	M1	5X112	66,45		O-P2016S	
X4 Type G02	2018	>								
X5 Type G05	2018	>								
X5 M Type G05	2019	>		20	M2a	5X112	66,45	M14X1,25	O-P2043C	
X6 Type G06 - G6X	2019	>								
X6 M Type G06	2019	>								
X7 Type G07	2019	>								
Z4 Type G29	2019	>		25	M5	5X112	66,45	M14X1,25	O-P2543CD	NEW
				30	M5	5X112	66,45	M14X1,25	O-P3043CD	NEW
				5	M1	5X120	72,5		O-P0507S	A-Y
				5	M2a	5X120	72,5	M14x1,50	O-P0545C	Y
				12	M1	5X120	72,5		O-P1207S	
				12	M2a	5X120	72,5	M14x1,50	O-P1245C	
				16	M1	5X120	72,5		O-P1607S	
				16	M2a	5X120	72,5	M14x1,50	O-P1645C	
				20	M1	5X120	72,5		O-P2007S	
				20	M2a	5X120	72,5	M14x1,50	O-P2045C	
				25	M5	5X120	72,5	M14x1,50	O-P2545CD	
				30	M5	5X120	72,5	M14x1,50	O-PN3045CD*	
				35	M5	5X120	72,5	M14x1,50	O-PN3545CD*	
				40	M5	5X120	72,5	M14x1,50	O-PN4045CD*	
Serie 7 E65	2002	Sept/2008								

BMW

MODELLO / MODEL	ANNO / YEAR DA / START A / END	NOTA CHIAVE KEY NOTE	SPESSORE THICKNESS (mm)	TIPO TYPE	INTERASSE C TO C	Ø	FILETTO THREAD	CODICE CODE #	NOTE NOTES
Serie 1 F20-F21 / 1K4 -1K2	June/2011	June/2011	5	M1	5X120	72,5		O-P0507S	A-Y
Serie 2 F22 / 1C	2013	2013	5	M2a	5X120	72,5	M14x1,25	O-P05128C	Y
Serie 2 Cabrio Type F23	2014	2014	5	M2a	5X120	72,5	M14x1,25	O-P05128C	Y
M2 Type F87	2015	2015	5	M2a	5X120	72,5	M14x1,25	O-P05128C	Y
M2 CS Type F87	2020	2020	5	M2a	5X120	72,5	M14x1,25	O-P05128C	Y
Serie 3 F30 3L	2012	2012	12	M1	5X120	72,5		O-P1207S	
Serie 3 Touring F31 3K	2012	2012	12	M1	5X120	72,5		O-P1207S	
Serie 3 GT F34 / 3V	Mar/2013	Mar/2013	12	M2a	5X120	72,5	M14x1,25	O-P12128C	
M3 F80	Jan/2014	Jan/2014	12	M2a	5X120	72,5	M14x1,25	O-P12128C	
Serie 4 F32 / 3C	2013	2013	16	M1	5X120	72,5		O-P1607S	
Serie 4 Cabrio F33 / 3C	2014	2014	16	M1	5X120	72,5		O-P1607S	
Serie 4 Coupé F36 / 3C	2014	2014	16	M2a	5X120	72,5	M14x1,25	O-P16128C	
M4 F82 - F83	Jan/2014	Jan/2014	16	M2a	5X120	72,5	M14x1,25	O-P16128C	
Serie 5 Type F10 / 5L	Apr/2010	Apr/2010	20	M1	5X120	72,5		O-P2007S	
Serie 5 Touring Type F11/5K	Apr/2010	Apr/2010	20	M1	5X120	72,5		O-P2007S	
Serie 5 GT Type F07 / GT	Nov/2009	Nov/2009	20	M2a	5X120	72,5	M14x1,25	O-P20128C	
M5 Type F10	June/2011	June/2011	20	M2a	5X120	72,5	M14x1,25	O-P20128C	
Serie 6 Cabrio Type F12/6C	2011	2011	25	M5	5X120	72,5	M14x1,25	O-P25127CD	
Serie 6 Coupe' Type F12/6C	2012	2012	25	M5	5X120	72,5	M14x1,25	O-P25127CD	
Serie 6 Gran Coupe' Type F13 / 6C	2012	2012	30	M5	5X120	72,5	M14x1,25	O-P30127CD	
M6 Cabrio Type F12	2012	2012	30	M5	5X120	72,5	M14x1,25	O-P30127CD	
M6 Coupe' Type F13	2012	2012	35	M5	5X120	72,5	M14x1,25	O-PN35127CD* NEW	
M6 Gran Coupe' Type F06	2013	2013	35	M5	5X120	72,5	M14x1,25	O-PN35127CD* NEW	
Serie 7 Type F01 / F02 (701- 7L - HY)	Oct/2008	Oct/2008	40	M5	5X120	72,5	M14x1,25	O-PN40127CD*	
X3 Type F25 - X-N1	2010	2010	40	M5	5X120	72,5	M14x1,25	O-PN40127CD*	
X4 Type F26 - X3	2014	2014	50	M5	5X120	72,5	M14x1,25	O-PN50127CD*	
Serie 5 / D E39	Nov/1995	June/2003	5	M1	5X120	74		O-P0534S	A-Y
M5 E39	Oct/1998	June/2003	5	M2a	5X120	74	M12x1,50	O-P0534C	Y
			12	M1	5X120	74		O-P1234S	
			12	M2a	5X120	74	M12x1,50	O-P1234C	
			16	M1	5X120	74		O-P1634S	
			16	M2a	5X120	74	M12x1,50	O-P1634C	
			20	M1	5X120	74		O-P2034S	
			20	M2a	5X120	74	M12x1,50	O-P2034C	
			20	M5	5X120	74	M12x1,50	O-PN2034CD*	
			25	M5	5X120	74	M12x1,50	O-P2534CD	
			25	M5	5X120	74	M12x1,50	O-P2534CD	
			30	M5	5X120	74	M12x1,50	O-P3034CD	
			35	M5	5X120	74	M12x1,50	O-PN3534CD*	
			40	M5	5X120	74	M12x1,50	O-PN4034CD*	
			65	M5	5X120	74	M12x1,50	O-PN6534CD*	
X3 E83	2003	Oct/2010	5	M1	5X120	72,5	M14x1,50	O-P0574S	A-Y
X5 E53	May/2000	Feb/2007	5	M2a	5X120	72,5	M14x1,50	O-P0574C	Y
			12	M1	5X120	72,5	M14x1,50	O-P1274S	
			12	M2a	5X120	72,5	M14x1,50	O-P1274C	
			16	M1	5X120	72,5	M14x1,50	O-P1674S	
			16	M2a	5X120	72,5	M14x1,50	O-P1674C	
			20	M1	5X120	72,5	M14x1,50	O-P2074S	
			20	M2a	5X120	72,5	M14x1,50	O-P2074C	
			20	M5	5X120	72,5	M14x1,50	O-PN2074CD*	
			25	M5	5X120	72,5	M14x1,50	O-P2574CD	
			30	M5	5X120	72,5	M14x1,50	O-P3074CD	
			40	M5	5X120	72,5	M14x1,50	O-PN4074CD*	
			45	M5	5X120	72,5	M14x1,50	O-PN4574CD*	
			50	M5	5X120	72,5	M14x1,50	O-PN5074CD*	

*DIAMOND FINISH / Finitura diamantata • Available in one week / Disponibile in una settimana

MODELLO / MODEL	ANNO / YEAR DA / START A / END	NOTA CHIAVE KEY NOTE	SPESSORE THICKNESS (mm)	TIPO TYPE	INTERASSE C TO C	Ø	FILETTO THREAD	CODICE CODE #	NOTE NOTES	
X5 Type X70 - Incl. Sport X5 Type F15 X6 Type F16	Mar/2007 Jan/2013 2015	Oct/2013 2018 2019		5	M1	5X120	74	M14x1,25	0-P0569S	A-Y
				5	M2a	5X120	74	M14x1,25	0-P0569C	Y
				12	M1	5X120	74	M14x1,25	0-P1269S	
				12	M2a	5X120	74	M14x1,25	0-P1269C	
				16	M1	5X120	74	M14x1,25	0-P1669S	
				16	M2a	5X120	74	M14x1,25	0-P1669C	
				20	M1	5X120	74	M14x1,25	0-P2069S	
				20	M2a	5X120	74	M14x1,25	0-P2069C	
				20	M5	5X120	74	M14x1,25	0-PN2069CD*	
				25	M5	5X120	74	M14x1,25	0-P2569CD	
				30	M5	5X120	74	M14x1,25	0-P3069CD	
X3 Type F25 X4 Type F26	Nov/2010 2014	2017 2018		5	M1	5X120	72,5		0-P0574S	A-Y
				5	M2a	5X120	72,5	M14x1,25	0-P05127C	Y
				12	M1	5X120	72,5		0-P1274S	
				12	M2a	5X120	72,5	M14x1,25	0-P12127C	
				16	M1	5X120	72,5		0-P1674S	
				16	M2a	5X120	72,5	M14x1,25	0-P16127C	
				20	M1	5X120	72,5		0-P2074S	
				20	M2a	5X120	72,5	M14x1,25	0-P20127C	
				20	M2a	5X120	72,5	M14x1,25	0-PN20127CD*	
				25	M5	5X120	72,5	M14x1,25	0-P25127CD	
				30	M5	5X120	72,5	M14x1,25	0-P30127CD	
				35	M5	5X120	72,5	M14x1,25	0-PN35127CD* NEW	
				40	M5	5X120	72,5	M14x1,25	0-PN40127CD*	
50	M5	5X120	72,5	M14x1,25	0-PN50127CD*					
X6 Type X71 / X72	2008	July/2014	1	5	M1	5X120	74		0-P0569S	A-Y
				5	M2a	5X120	74	M14x1,25	0-P0569C	Y
				12	M1	5X120	74		0-P1269S	
				12	M2a	5X120	74	M14x1,25	0-P1269C	
				16	M1	5X120	74		0-P1669S	
				16	M2a	5X120	74	M14x1,25	0-P1669C	
				20	M1	5X120	74		0-P2069S	
				20	M2a	5X120	74	M14x1,25	0-P2069C	
				20	M5	5X120	74	M14x1,25	0-PN2069CD*	
				25	M5	5X120	74	M14x1,25	0-P2569CD	
				30	M5	5X120	74	M14x1,25	0-P3069CD	
				35	M5	5X120	74	M14x1,25	0-PN3569CD*	
				40	M5	5X120	74	M14x1,25	0-PN4069CD*	
				45	M5	5X120	74	M14x1,25	0-PN4569CD*	
50	M5	5X120	74	M14x1,25	0-PN5069CD*					

BMW

MODELLO / MODEL	ANNO / YEAR DA / START A / END	NOTA CHIAVE KEY NOTE	SPESSORE THICKNESS (mm)	TIPO TYPE	INTERASSE C TO C	Ø	FILETTO THREAD	CODICE CODE #	NOTE NOTES	
X6 Type X71 / X72	2008	July/2014	2	5	M1	5X120	72,5		O-P0574S	A-Y
				5	M2a	5X120	72,5	M14x1,25	O-PN0574C*	Y
				12	M1	5X120	72,5		O-P05127C	Y
				12	M2a	5X120	72,5	M14x1,25	O-P1274S	
				16	M2a	5X120	72,5	M14x1,25	O-P12127C	
				16	M1	5X120	72,5		O-P1674S	
				16	M2a	5X120	72,5	M14x1,25	O-P16127C	
				20	M1	5X120	72,5		O-P2074S	
				20	M2a	5X120	72,5	M14x1,25	O-P2074C	
				25	M5	5X120	72,5	M14x1,25	O-P25127CD	
				30	M5	5X120	72,5	M14x1,25	O-P30127CD	
				35	M5	5X120	72,5	M14x1,25	O-PN35127CD* NEW	
				40	M5	5X120	72,5	M14x1,25	O-PN40127CD*	
50	M5	5X120	72,5	M14x1,25	O-PN50127CD*					

CADILLAC

MODELLO / MODEL	ANNO / YEAR DA / START A / END	NOTA CHIAVE KEY NOTE	SPESSORE THICKNESS (mm)	TIPO TYPE	INTERASSE C TO C	Ø	FILETTO THREAD	CODICE CODE #	NOTE NOTES	
BLS Type YSCF	Mar/2006	2009		5	M1	5X110	65		O-P0540S	A-Y
				5	M2a	5X110	65	M12x1,50	O-P0540C	Y
				17	M1	5X110	65		O-P1740S	
				17	M2a	5X110	65	M12x1,50	O-P1740C	
				20	M1	5X110	65		O-P2040S	
				20	M2a	5X110	65	M12x1,50	O-P2040C	
				40	M5	5X110	65	M12x1,50	O-PN4040CD*	
				50	M5	5X110	65	M12x1,50	O-PN5040CD*	

CHEVROLET

MODELLO / MODEL	ANNO / YEAR DA / START A / END	NOTA CHIAVE KEY NOTE	SPESSORE THICKNESS (mm)	TIPO TYPE	INTERASSE C TO C	Ø	FILETTO THREAD	CODICE CODE #	NOTE NOTES	
Aveo 1,6 Type KL1T Cruze Type KL1J 1,6 16V - 1,8 16V Trax Type KL1B	May/2011	>	3	20	M4	5X105	56,5	M12X1,50	O-P2095CD	M
	Apr/2009	>		25	M4	5X105	56,5	M12X1,50	O-P2595CD	M
	2013	>		30	M4	5X105	56,5	M12X1,50	O-P3095CD	M
Captive Type CLAC Cruze Type KL1J 2,0 VCDI 150/163CV Orlando Type KL1Y	July/2006	2011	4	20	M4	5X115	70	M12X1,50	O-P2096CD	M
	Apr/2009	2016		25	M4	5X115	70	M12X1,50	O-P2596CD	M
	Feb/2011	>		30	M4	5X115	70	M12X1,50	O-P3096CD	M
				35	M4	5X115	70	M12X1,50	O-PN3596CD*	M
				40	M4	5X115	70	M12X1,50	O-PN4096CD*	M
Camaro Type F-CAR Corvette C4 Type Y-1Y-1G1YY- 1G1AY Corvette C5 Type Y Corvette C6 Type GMX245-GMX245 S Corvette C7 Type Y1BC Corvette C7 Grand Sport Type Y1BC Corvette C7 Z06 Type Y1BC	1994	2002		5	M1	5x120,65	70,2		O-PN0579S*	
	1984	1996		20	M4	5x120,65	70,2	M12x1,50	O-PN2079CD*	M
	1997	2004		25	M4	5x120,65	70,2	M12x1,50	O-PN2579CD*	M
	2005	2013		30	M4	5x120,65	70,2	M12x1,50	O-PN3079CD*	M
	2013	>		40	M4	5x120,65	70,2	M12x1,50	O-PN4079CD*	M
	2017	>		45	M4	5x120,65	70,2	M12x1,50	O-PN4579CD*	M
	2014	>								

*DIAMOND FINISH / Finitura diamantata • Available in one week / Disponibile in una settimana

CHRYSLER

MODELLO / MODEL	ANNO / YEAR DA / START A / END	NOTA CHIAVE KEY NOTE	SPESSORE THICKNESS (mm)	TIPO TYPE	INTERASSE C TO C	Ø	FILETTO THREAD	CODICE CODE #	NOTE NOTES
Crossfire Type ZH	July/03	Dec/2010	5	M1	5X112	66,5		0-P0516S	A-Y
			5	M2a	5X112	66,5	M12X1,50	0-P0516C	C-Y
			5	M3a	5X112	66,5	M12X1,50	0-P0516CS	B-Y
			12	M1	5X112	66,5		0-P1216S	
			12	M2a	5X112	66,5	M12X1,50	0-P1216C	C
			12	M3a	5X112	66,5	M12X1,50	0-P1216CS	B
			16	M1	5X112	66,5		0-P1616S	
			16	M2a	5X112	66,5	M12X1,50	0-P1616C	C
			16	M3a	5X112	66,5	M12X1,50	0-P1616CS	B
			20	M1	5X112	66,5		0-P2016S	
			20	M2a	5X112	66,5	M12X1,50	0-P2016C	C
			20	M3a	5X112	66,5	M12X1,50	0-P2016CS	B
Sebring Type JS	June/2007	Dec/2010	5	M1	5X114,3	67		0-P0556S	A-Y
			16	M1	5X114,3	67		0-P1656S	
			16	M2b	5X114,3	67	M12X1,50	0-P1656C	L
			16	M2b	5X114,3	67	M12X1,50	0-P1659C	R
			20	M1	5X114,3	67		0-P2056S	
			20	M2b	5X114,3	67	M12X1,50	0-P2056C	L
			20	M2b	5X114,3	67	M12X1,50	0-P2059C	R
			20	M4	5X114,3	67	M12X1,50	0-P2056CD	M-H
300 C Type LX 300C Touring Type LX 300 C SRT8 Type LX SRT8	2004	2011	20	M4	5X115	71,5	M14X1,50	0-P2072CD	M
	2004	2011	25	M4	5X115	71,5	M14X1,50	0-P2572CD	M
	2004	2011	30	M4	5X115	71,5	M14X1,50	0-PN3072CD*	M
Voyager III Grand Voyager Type GS / RG 300M Type LR	Feb/2000	2006	30	M4	5X114,3	71,5	M12X1,50	0-PFSC230	M-H
	Feb/2000 July/1998	Feb/2007 Sept/2004	40	M4	5X114,3	71,5	M12X1,50	0-PNFSC240*	H
Grand Voyager IV Type RT Pacifica	Oct/2007 2004	> 2007	30	M4	5X127	71,5	M12x1,5	0-PFSF330	M-H
Daytona Type Daytona Le Baron Type 1 GEN - 3 GEN Neon Type 1 GEN - 2 GEN PT Cruiser Type PT Saratoga Type 7 GEN Sebring Type JR Stratus Type JA	1984	1993	20	M4	5x100	57	M12x1,50	0-PN2078CD*	M
	1977	1985	30	M4	5x100	57	M12x1,50	0-PN3078CD*	M
	1994	2002	40	M4	5x100	57	M12x1,50	0-PN4078CD*	M

CITROËN

MODELLO / MODEL	ANNO / YEAR DA / START A / END	NOTA CHIAVE KEY NOTE	SPESSORE THICKNESS (mm)	TIPO TYPE	INTERASSE C TO C	Ø	FILETTO THREAD	CODICE CODE #	NOTE NOTES
AX - Saxo - Visa	1986	2002	5	16	M1	3X98	55		0-P1603S
				16	M2a	3X98	55	M12X1,25	0-P1603C
				20	M1	3X98	55		0-P2003S
				20	M2a	3X98	55	M12X1,25	0-P2003C
C1 Type P C1 Type PA- PS	2005 2014	2013 >	5	M1	4X100	54		0-PN0514S*	
			16	M1	4X100	54		0-P1614S	
			16	M2a	4X100	54	M12X1,50	0-P1665C	C
			16	M2a	4X100	54	M12X1,50	0-P16112C	U
			20	M1	4X100	54		0-P2014S	
			20	M2a	4X100	54	M12X1,50	0-P2065C	C
			20	M2a	4X100	54	M12X1,50	0-P20112C	U

*DIAMOND FINISH / Finitura diamantata • Available in one week / Disponibile in una settimana

CITROËN

MODELLO / MODEL	ANNO / YEAR DA / START	YEAR A / END	NOTA CHIAVE KEY NOTE	SPESSORE THICKNESS (mm)	TIPO TYPE	INTERASSE C TO C	Ø	FILETTO THREAD	CODICE CODE #	NOTE NOTES
AX GTI Type ZA BX Type XB Berlingo Type M C3 Type F C5 Type D Xantia Type X Xsara Type N Saxo Type S0 /S1 Visa GTI ZX Type N2	1991 1982 1996 2002 2000 1993 1997 Feb/1996 June/1986 1991	1998 1994 July/2003 July/2003 July/2003 2001 2005 Apr/2004 Mar/1991 1998	8 8 8 8 6-8 8 8 8 8 8 8 8 8 8 8 8	5	M1	4X108	65		0-P0518S	A-Y
				5	M2a	4X108	65	M12X1,25	0-P0518C	C-Y
				12	M1	4X108	65		0-P1218S	
				12	M2a	4X108	65	M12X1,25	0-P1218C	C
				16	M1	4X108	65		0-P1618S	
				16	M2a	4X108	65	M12X1,25	0-P1618C	C
				20	M1	4X108	65		0-P2018S	
				20	M2s	4X108	65	M12X1,25	0-PN2018AC*	NEW
				20	M2a	4X108	65	M12X1,25	0-P2018C	C
				25	M5	4X108	65	M12X1,25	0-P2518CD	
				30	M5	4X108	65	M12X1,25	0-P3018CD	
				30	M6	4X108	65	M12X1,25	0-PN3018CDP*	
				35	M5	4X108	65	M12X1,25	0-P3518CD	
				40	M5	4X108	65	M12X1,25	0-P4018CD	
				45	M5	4X108	65	M12X1,25	0-P4518CD	
				50	M5	4X108	65	M12X1,25	0-P5018CD	
				Berlingo Type G Berlingo Type 7 C2 Type J C3 Type F C3 Pluriel Type H C3 Type S C3 Picasso Type SH C3 Type SX C3 Aircross Type II C4 Cactus C4 I Type L C4 II Type N C4 I Picasso Type U C5 Type R DS3 Type S DS3 Crossback Type U DS4 Type N DS5 Type K	Jan/1997 June/2008 Aug/2003 Aug/2003 Aug/2003 2009 2009 2017 2009 2017 2017 2017 Aug/2014 2004 Jan/2010 Nov/2006 Aug/2003 Jan/2010 2018 2011 2011	mar-08 2018 2010 2009 2009 2017 2017 > > > Nov/2010 > Feb/2013 May/2008 2019 > > >	9 9 9 9 9 9 9 9 9 9 9 9 9 9 9 9 9 9 9 9	5	M1	4X108
5	M2a	4X108	65					M12X1,25	0-P0518C7	C-Y
5	M3b	4X108	65					M12X1,25	0-P0518CP7	S-Y
12	M1	4X108	65						0-P1218S	
12	M2a	4X108	65					M12X1,25	0-P1218C7	C
12	M3b	4X108	65					M12X1,25	0-P1218CP7	S
16	M1	4X108	65						0-P1618S	
16	M2a	4X108	65					M12X1,25	0-P1618C7	C
16	M3b	4X108	65					M12X1,25	0-P1618CP7	S
20	M1	4X108	65						0-P2018S	
20	M2s	4X108	65					M12X1,25	0-PN2018AC*	NEW
20	M2a	4X108	65					M12X1,25	0-P2018C7	C
20	M3b	4X108	65					M12X1,25	0-P2018CP7	S
25	M5	4X108	65					M12X1,25	0-P2518CD	
30	M5	4X108	65					M12X1,25	0-P3018CD	
30	M6	4X108	65					M12X1,25	0-PN3018CDP*	
35	M5	4X108	65					M12X1,25	0-P3518CD	
40	M5	4X108	65					M12X1,25	0-P4018CD	
45	M5	4X108	65					M12X1,25	0-P4518CD	
50	M5	4X108	65					M12X1,25	0-P5018CD	
Nemo Type A	2008	>		5	M1	4X98	58		0-P0510S	A-Y
				5	M2a	4X98	58	M12X1,25	0-P0510C7	B-Y
				5	M2a	4X98	58	M12X1,25	0-P05105C	C-Y
				6	M2a	4X98	58	M12X1,25	0-P1610C7	B
				12	M1	4X98	58		0-P1210S	
				12	M2a	4X98	58	M12X1,25	0-P1210C7	B
				12	M2a	4X98	58	M12X1,25	0-P12105C	C
				16	M1	4X98	58		0-P1610S	
				16	M2a	4X98	58	M12X1,25	0-P16105C	C
				20	M1	4X98	58		0-P2010S	
				20	M2a	4X98	58	M12X1,25	0-P2010C7	B
				20	M2a	4X98	58	M12X1,25	0-P20105C	C
				25	M5	4X98	58	M12X1,25	0-P2510CD	
				30	M5	4X98	58	M12X1,25	0-P3010CD	
				35	M5	4X98	58	M12X1,25	0-P3510CD	
				40	M5	4X98	58	M12X1,25	0-P4010CD	
				45	M5	4X98	58	M12X1,25	0-P4510CD	
50	M5	4X98	58	M12X1,25	0-P5010CD					

*DIAMOND FINISH / Finitura diamantata • Available in one week / Disponibile in una settimana

CITROËN

MODELLO / MODEL	ANNO / YEAR DA / START A / END	NOTA CHIAVE KEY NOTE	SPESSORE THICKNESS (mm)	TIPO TYPE	INTERASSE C TO C	Ø	FILETTO THREAD	CODICE CODE #	NOTE NOTES	
C8 Type E Evasion Type 22/U6/A JUMPY I Type U64 / USU / B	2002 June/1994 June/1994	2008 July/2002 Feb/2007		5	M1	5X98	58		0-P0504S	A-Y
				5	M2a	5X98	58	M14X1,50	0-P0549C	Y
				12	M1	5X98	58		0-P1204S	
				12	M2a	5X98	58	M14X1,50	0-P1249C	
				16	M1	5X98	58		0-P1604S	
				16	M2a	5X98	58	M14X1,50	0-P1649C	
Berlingo Type K9 C4 II Picasso Type 3 C4 Gran Picasso II C5 Type R (RC) C5 Type R (RD) C5 Aircross Type 5D C5 Aircross Hybrid Type 5D C6 Type T DS7 Crossback Type J Jumpy II Type X Spacetourer Type X XM Type Y3-4	2018 Mar/13 Sept/13 2004 2008 2017 2017 2020 2005 2018 Jan/2007 2016 May/1989	> > > 2008 2017 > > Dec/2012 > > > Oct/2000	7 7	5	M1	5X108	65		0-P0531S	A-Y
				5	M2a	5X108	65	M12X1,25	0-P0558C7	C-Y
				5	M3b	5X108	65	M12X1,25	0-P0558CP7	S-Y
				12	M1	5X108	65		0-P1231S	
				12	M2a	5X108	65	M12X1,25	0-P1258C7	C
				12	M3b	5X108	65	M12X1,25	0-P1258CP7	S
				16	M1	5X108	65		0-P1631S	
				16	M2a	5X108	65	M12X1,25	0-P1658C7	C
				16	M3b	5X108	65	M12X1,25	0-P1658CP7	S
				20	M1	5X108	65		0-P2031S	
				20	M2a	5X108	65	M12X1,25	0-P2058C7	C
				20	M3b	5X108	65	M12X1,25	0-P2058CP7	S
				25	M5	5X108	65	M12X1,25	0-PN2558CD*	
				30	M5	5X108	65	M12X1,25	0-PN3058CD*	
				35	M5	5X108	65	M12X1,25	0-PN3558CD*	
40	M5	5X108	65	M12X1,25	0-PN4058CD*	NEW				
50	M5	5X108	65	M12X1,25	0-PN5058CD*					
C-CROSSER Type V C4 AIRCROSS Type B	Jan/2007 Apr/2012	2013 2017		5	M1	5X114,3	67		0-P0556S	A-Y
				16	M1	5X114,3	67		0-P1656S	
				16	M2b	5X114,3	67	M12X1,50	0-P1656C	L
				16	M2b	5X114,3	67	M12X1,50	0-P1659C	R
				20	M1	5X114,3	67		0-P2056S	
				20	M2b	5X114,3	67	M12X1,50	0-P2056C	L
				20	M2b	5X114,3	67	M12X1,50	0-P2059C	R
				20	M4	5X114,3	67	M12X1,50	0-P2056CD	M-H
				25	M4	5X114,3	67	M12X1,50	0-P2556CD	M-H
				30	M4	5X114,3	67	M12X1,50	0-P3056CD	M-H
				35	M4	5X114,3	67	M12X1,50	0-PN3556CD*	H
				40	M4	5X114,3	67	M12X1,50	0-PN4056CD*	H
				45	M4	5X114,3	67	M12X1,50	0-PN4556CD*	NEW
50	M4	5X114,3	67	M12X1,50	0-PN5056CD*	H				

DACIA

MODELLO / MODEL	ANNO / YEAR DA / START A / END	NOTA CHIAVE KEY NOTE	SPESSORE THICKNESS (mm)	TIPO TYPE	INTERASSE C TO C	Ø	FILETTO THREAD	CODICE CODE #	NOTE NOTES	
Logan Type SD/SR Sandero / Stepway Type SD	Sept/2004 May/2008	> Dec/2012		5	M1	4X100	60		0-P0519S	A-Y
				5	M2a	4X100	60	M12X1,50	0-P0519C	Y
				17	M1	4X100	60		0-P1719S	
				17	M2a	4X100	60	M12X1,50	0-P1719C	
				20	M1	4X100	60		0-P2019S	
				20	M2a	4X100	60	M12X1,50	0-P2019C	
				25	M5	4X100	60	M12X1,50	0-P2519CD	
				30	M5	4X100	60	M12X1,50	0-P3019CD	
				35	M5	4X100	60	M12X1,50	0-P3519CD	
				40	M5	4X100	60	M12X1,50	0-P4019CD	
				45	M5	4X100	60	M12X1,50	0-P4519CD	
				50	M5	4X100	60	M12X1,50	0-P5019CD	

*DIAMOND FINISH / Finitura diamantata • Available in one week / Disponibile in una settimana

DACIA

MODELLO / MODEL	ANNO / YEAR DA / START A / END	NOTA CHIAVE KEY NOTE	SPESSORE THICKNESS (mm)	TIPO TYPE	INTERASSE C TO C	Ø	FILETTO THREAD	CODICE CODE #	NOTE NOTES
Dokker Type SD Lodgy Type SD Sandero / Stepway Type SD/DR Sandero / Stepway Type DJF	Sept/2012 2012 2012 2021	> > 2020 >	5	M1	4X100	60		0-P0519S	A-Y
			5	M2a	4X100	60	M12X1,50	0-P0519C7	B-Y
			17	M1	4X100	60		0-P1719S	
			17	M2a	4X100	60	M12X1,50	0-P1719C7	B
			20	M1	4X100	60		0-P2019S	
			20	M2a	4X100	60	M12X1,50	0-P2019C7	B
			25	M5	4X100	60	M12X1,50	0-P2519CD	
			30	M5	4X100	60	M12X1,50	0-P3019CD	
			35	M5	4X100	60	M12X1,50	0-P3519CD	
			40	M5	4X100	60	M12X1,50	0-P4019CD	
			45	M5	4X100	60	M12X1,50	0-P4519CD	
			50	M5	4X100	60	M12X1,50	0-P5019CD	
Duster Type SD Duster II Type SR	Apr/2010 2018	2018 >	5	M1	5X114,3	66		0-P0553S	A-Y
			17	M1	5X114,3	66		0-P1775S	
			17	M2a	5X114,3	66	M12X1,50	0-P1776C	
			20	M1	5X114,3	66		0-P2075S	
			20	M2a	5X114,3	66	M12X1,50	0-P2076C	
			20	M5	5X114,3	66	M12X1,50	0-PN2076CD*	
			25	M5	5X114,3	66	M12X1,50	0-PN2576CD*	
			30	M5	5X114,3	66	M12X1,50	0-PN3076CD*	
			30	M5	5X114,3	66	M12X1,50	0-PN3076CD*	
			35	M5	5X114,3	66	M12X1,50	0-PN3576CD*	
			40	M5	5X114,3	66	M12X1,50	0-PN4076CD*	
			45	M5	5X114,3	66	M12X1,50	0-PN4576CD*	
50	M5	5X114,3	66	M12X1,50	0-PN5076CD*				

DAIHATSU

MODELLO / MODEL	ANNO / YEAR DA / START A / END	NOTA CHIAVE KEY NOTE	SPESSORE THICKNESS (mm)	TIPO TYPE	INTERASSE C TO C	Ø	FILETTO THREAD	CODICE CODE #	NOTE NOTES
Copen Type L8 Cuore Type L2/L7/L27 YRV Type M2 Materia Type M4 Sirion Type M3 Trevis Type L65	2004 2003 Feb/2001 2007 2005 2006	2010 > 2005 > > >	5	M1	4X100	54		0-PN0514S*	
			16	M1	4X100	54		0-P1614S	
			16	M2b	4X100	54	M12X1,50	0-P1614C	L
			20	M1	4X100	54		0-P2014S	
			20	M2b	4X100	54	M12X1,50	0-P2014C	L
			20	M4	4X100	54	M12X1,50	0-P2014CD	M
			20	M4	4X100	54	M12X1,50	0-P2014CD	M
Charade Type all Models Applause Type A1 / A101 Grand Move Type G3	1990 July/1997 1996	2013 May/2000 2001	5	M1	4X100	56		0-P0539S	A-Y
			16	M1	4X100	56		0-P1639S	
			16	M2b	4X100	56	M12X1,50	0-P16113C	L
			20	M1	4X100	56		0-P2039S	
			20	M2b	4X100	56	M12X1,50	0-P20113C	L
			20	M4	4X100	56	M12X1,50	0-P2013CD	M

*DIAMOND FINISH / Finitura diamantata • Available in one week / Disponibile in una settimana

DAIHATSU (Off-road)

MODELLO / MODEL	ANNO / YEAR DA / START	A / END	NOTA CHIAVE KEY NOTE	SPESSORE THICKNESS (mm)	TIPO TYPE	INTERASSE C TO C	Ø	FILETTO THREAD	CODICE CODE #	NOTE NOTES
Feroza Type F300	Oct/1988	1999		30	M4	5X139,7	108	M12X1,50	0-PFSD130	Y
Wildcat / Rocky Type F70 / F75	Feb/1985	Apr/1987		40	M4	5X139,7	108	M12X1,50	0-PNFSD140*	Y
Terios I Type J1	Oct/1997	Mar/2006		30	M4	5X114,3	66,5	M12X1,50	0-PFSD230	H
Terios II Type J2	Apr/2006	>								

DAEWOO

MODELLO / MODEL	ANNO / YEAR DA / START	A / END	NOTA CHIAVE KEY NOTE	SPESSORE THICKNESS (mm)	TIPO TYPE	INTERASSE C TO C	Ø	FILETTO THREAD	CODICE CODE #	NOTE NOTES
Matiz Type KLYA - KLYK	1998	2004		50	M4	4x114,3	69	M12x1,25	0-PN5047CD*	

DODGE

MODELLO / MODEL	ANNO / YEAR DA / START	A / END	NOTA CHIAVE KEY NOTE	SPESSORE THICKNESS (mm)	TIPO TYPE	INTERASSE C TO C	Ø	FILETTO THREAD	CODICE CODE #	NOTE NOTES
Journey Type JC	Sept/2008	June/2015		25	M4	5X127	71,5	M12X1,50	0-PFSF325	M-H
				30	M4	5X127	71,5	M12X1,50	0-PFSF330	M-H
Durango Type III	2011	>		25	M4	5X127	71,5	M14X1,50	0-PNFSJ225* NEW	M-H
				30	M4	5X127	71,5	M14X1,50	0-PFSJ230	M-H
				40	M4	5X127	71,5	M14X1,50	0-PNFSJ230*	M-H
Avenger Type JS Caliber Type PK Steals Type Steals	June/2007 May/2006 1990	> 2011 2000		20	M4	5X114,3	67	M12X1,50	0-P2056CD	M-H
				25	M4	5X114,3	67	M12X1,50	0-P2556CD	M-H
				30	M4	5X114,3	67	M12X1,50	0-P3056CD	M-H
Nitro Type KJ	May/2007	2011		30	M4	5X114,3	71,5	1/2"UNF	0-PFSC130	H
				35	M4	5X114,3	71,5	1/2"UNF	0-PNFSC135*	H
				40	M4	5X114,3	71,5	1/2"UNF	0-PNFSC140*	H
				50	M4	5X114,3	71,5	1/2"UNF	0-PNFSC150* NEW	H
Dodge RAM Type MK5	2019	>		30	M4	6X139,7	77,8	M14X1,50	0-PNFSD330*	M-H
				50	M4	6X139,7	77,8	M14X1,50	0-PNFSD350*	H
Dodge RAM Type MK4	2012	>		30	M4	5X139,7	77,8	M14X1,50	0-PNFSD530* NEW	M-H
				40	M4	5X139,7	77,8	M14X1,50	0-PNFSD540* NEW	H
				45	M4	5X139,7	77,8	M14X1,50	0-PNFSD545* NEW	H
Challenger II Type MK2 Challenger III Type LC Charger Type LX Charger Type LD Magnum II Type LX	1978 2008 2005 2011 2004	1983 up 2010 up 2008		30	M4	5X139,7	77,8	M14X1,50	0-PNFSD530* NEW	M-H
				40	M4	5X139,7	77,8	M14X1,50	0-PNFSD540* NEW	H
				30	M4	6X139,7	77,8	M14X1,50	0-PNFSD330* NEW	M-H
				50	M4	6X139,7	77,8	M14X1,50	0-PNFSD350* NEW	H

*DIAMOND FINISH / Finitura diamantata • Available in one week / Disponibile in una settimana

FERRARI

MODELLO / MODEL	ANNO / YEAR DA / START	A / END	NOTA CHIAVE KEY NOTE	SPESSORE THICKNESS (mm)	TIPO TYPE	INTERASSE C TO C	Ø	FILETTO THREAD	CODICE CODE #	NOTE NOTES
F430 / Spider Type F 131	Mar/2005	2009	12-13	16	M2a	5X108	67	M14x1,50	O-P1644C	K
F308 GTB Type F106	Sept/1985	Sept/1989	12-13	16	M2a	5X108	67	M14x1,50	O-P16119C	V
F328 GTS Type F106	Sept/1985	Sept/1989	12-13	20	M2a	5X108	67	M14x1,50	O-P2044C	J
F348 TB / TS / Spider Type F119	Aug/1990	Dec/1995	12-13	20	M2a	5X108	67	M14x1,50	O-P20119C	K
F355 GTS / Berlinetta Type F 129	May/1994	Mar/1999	12-13	20	M5	5X108	67	M14x1,50	O-PN2044CD*	
F360 Modena / Spider Type F131	Mar/1999	2004	12-13	30	M5	5X108	67	M14x1,50	O-PN3044CD*	
F456 GT/GTA Type F116	Jan/1993	2004	12-13	35	M5	5X108	67	M14x1,50	O-PN3544CD	NEW
F512 M Type F110 Incl. TR	Jan/1994	Aug/1996	12-13	95	M4	5X108	67	M14x1,50	O-PNFERR95CD*	
F550 Maranello Type F133	Sept/1996	2001	12-13	16	M2a	5X114	67	M14x1,50	O-P16120C	V
F550 Barchetta Type F133	2000	2001	12-13	16	M2a	5X114	67	M14x1,50	O-P16121C	K
F575 M Type F133	2002	2006	12-13	20	M2a	5X114	67	M14x1,50	O-P20120C	K
Mondial Type F 108	July/1980	Dec/1993	12-13	20	M2a	5X114	67	M14x1,50	O-P20121C	J
Testarossa Type F110	May/1984	Dec/1991	12-13	25	M5	5X114	67	M14x1,50	O-PN20120CD*	
599 GTB Fiorano Type F141	June/2006	>	12-13	25	M5	5X114	67	M14x1,50	O-PN25120CD*	
California Type F149	July/2008	>	12-13	25	M5	5X114	67	M14x1,50	O-PN25120CD*	
F 612 Scaglietti Type F 137	Apr/2004	2010	12-13	30	M5	5X114	67	M14x1,50	O-PN30120CD*	
458 Incl. Spider Type 142	2009	>	12-13	30	M5	5X114	67	M14x1,50	O-PN30120CD*	
488 Incl. Spider Type 142M	2015	>	12-13	45	M5	5X114	67	M14x1,50	O-PN45120CD*	NEW
FF Type F151	2011	>	12-13	50	M5	5X114	67	M14x1,50	O-PN50120CD*	NEW
F12 Type 152	2012	>	12-13							
812 Superfast Type F140GA	2017	>	12-13							
F8 Tributo Type F154CD	2019	>	12-13							
GTC4 Lusso Type F154BD	2016	>	12-13							
Portofino Type F154BE	2017	>	12-13							

FIAT

MODELLO / MODEL	ANNO / YEAR DA / START	A / END	NOTA CHIAVE KEY NOTE	SPESSORE THICKNESS (mm)	TIPO TYPE	INTERASSE C TO C	Ø	FILETTO THREAD	CODICE CODE #	NOTE NOTES
124 Spider Type NC-NF	2016	>		20	M4	4X100	54	M12X1,50	O-P2014CD	M
124 Spider (NO SPECIAL) Type 124CS/124CS1	1966	1985	11	5	M1	4X98	58		O-P0510S	A-Y
128 Coupé Type 128AC	1972	1975	11	5	M2a	4X98	58	M12X1,25	O-P0510C	Y
Brava / Bravo Type 182	1995	2001	11	8	M1	4X98	58		O-PN0810S*	Y
Cinquecento Type 170	July/1991	Jan/1998	11	12	M1	4X98	58	M12X1,25	O-P1210S	
Croma Type 154	Dec/1985	Dec/1996	11	12	M2a	4X98	58	M12X1,25	O-P1210C	
Marea Type 185	1995	2004	11	16	M1	4X98	58		O-P1610S	
Panda Type 141A	Mar/1980	Aug/2003	11	16	M2a	4X98	58	M12X1,25	O-P1610C	
Punto Type 176	1993	2002	11	20	M1	4X98	58		O-P2010S	
Seicento Type 187	Jan/1998	June/2000	11	20	M2a	4X98	58	M12X1,25	O-P2010C	
Tipo Type 160	July/1987	Apr/1995	11	25	M5	4X98	58	M12X1,25	O-P2510CD	
Uno Type 146A/E	Jan/1983	Aug/2000	11	28	M1	4X98	58		O-PN2810S*	
X 1/9 Type 128 AS	Nov/1972	Dec/1989	11	30	M1	4X98	58		O-PN3010S*	
				30	M5	4X98	58	M12X1,25	O-P3010CD	
				35	M5	4X98	58	M12X1,25	O-P3510CD	
				40	M5	4X98	58	M12X1,25	O-P4010CD	
				45	M5	4X98	58	M12X1,25	O-P4510CD	
				50	M5	4X98	58	M12X1,25	O-P5010CD	
				80	M5	4X98	58	M12X1,25	O-PN8010CD*	

*DIAMOND FINISH / Finitura diamantata • Available in one week / Disponibile in una settimana

FIAT

MODELLO / MODEL	ANNO / YEAR DA / START A / END	NOTA CHIAVE KEY NOTE	SPESSORE THICKNESS (mm)	TIPO TYPE	INTERASSE C TO C	Ø	FILETTO THREAD	CODICE CODE #	NOTE NOTES		
Barchetta Type 183 Coupé Type 175	1994 1994	2002 2000		5	M1	4X98	58		O-P0510S	A-Y	
				5	M2a	4X98	58	M12X1,25	O-P05118C	Y	
				8	M1	4X98	58		O-PN0810S*		
				12	M1	4X98	58		O-P1210S		
				12	M2a	4X98	58	M12X1,25	O-P12118C		
				16	M1	4X98	58		O-P1610S		
				16	M2a	4X98	58	M12X1,25	O-P16118C		
				20	M1	4X98	58	M12X1,25	O-P2010S		
				20	M2a	4X98	58	M12X1,25	O-P20118C		
				25	M5	4X98	58	M12X1,25	O-P2510CD		
				28	M1	4X98	58		O-PN2810S*		
				30	M1	4X98	58		O-PN3010S*		
				30	M5	4X98	58	M12X1,25	O-P3010CD		
				35	M5	4X98	58	M12X1,25	O-P3510CD		
				40	M5	4X98	58	M12X1,25	O-P4010CD		
				45	M5	4X98	58	M12X1,25	O-P4510CD		
				50	M5	4X98	58	M12X1,25	O-P5010CD		
	80	M5	4X98	58	M12X1,25	O-PN8010CD*					
500 E Type FCA-FA1-332 500 Type 312 Bravo Type 198 Doblo` Type 223/L Idea Type 350 Fiorino (QUBO) Type 225 Linea Type 323 Multipla Type 186 Punto Type 188 Nuova Panda Type 169 Nuova Panda Type 312 Stilo Type 192	2020 2007 2007 2001 2004 2008 2007 1997 2003 Mar/2004 2013 2001	> > > Dec /2009 2016 > > June/2010 2009 2012 > 2006	10 10 10 10 10 10 10 10 10 10 10 10 10 10 10 10		5	M1	4X98	58		O-P0510S	A-Y
					5	M2a	4X98	58	M12X1,25	O-P0510C7	B-Y
					5	M2a	4X98	58	M12X1,25	O-P05105C	C-Y
					12	M1	4X98	58		O-P1210S	
					12	M2a	4X98	58	M12X1,25	O-P1210C7	B
					12	M2a	4X98	58	M12X1,25	O-P12105C	C
					16	M1	4X98	58		O-P1610S	
					16	M2a	4X98	58	M12X1,25	O-P1610C7	B
					16	M2a	4X98	58	M12X1,25	O-P16105C	C
					20	M1	4X98	58		O-P2010S	
					20	M2a	4X98	58	M12X1,25	O-P2010C7	B
					20	M2a	4X98	58	M12X1,25	O-P20105C	C
					25	M5	4X98	58	M12X1,25	O-P2510CD	
					30	M5	4X98	58	M12X1,25	O-P3010CD	
					35	M5	4X98	58	M12X1,25	O-P3510CD	
					40	M5	4X98	58	M12X1,25	O-P4010CD	
					45	M5	4X98	58	M12X1,25	O-P4510CD	
	50	M5	4X98	58	M12X1,25	O-P5010CD					
Nuova Grande Punto Type 199 Punto EVO Type 199 Punto Type 199	Oct/2005 Oct/2009 Mar/2012	Sept/2009 Feb/2012 >		5	M1	4X100	56,5		O-P0517S	A-Y	
				5	M2a	4X100	56,5	M12X1,50	O-P0517C	B-Y	
				5	M2a	4X100	56,5	M12X1,50	O-P05106C	C-Y	
				12	M1	4X100	56,5	M12X1,50	O-PN1217S*	D	
				12	M2a	4X100	56,5	M12X1,50	O-PN1217C*	D	
				17	M1	4X100	56,5		O-P1717S		
				17	M2a	4X100	56,5	M12X1,50	O-P1717C	B	
				17	M2a	4X100	56,5	M12X1,50	O-P17106C	C	
				20	M1	4X100	56,5		O-P2017S		
				20	M2a	4X100	56,5	M12X1,50	O-P2017C	B	
				20	M2a	4X100	56,5	M12X1,50	O-P20106C	C	
				25	M5	4X100	56,5	M12X1,50	O-P2517CD		
				30	M5	4X100	56,5	M12X1,50	O-P3017CD		
				35	M5	4X100	56,5	M12X1,50	O-P3517CD		
				40	M5	4X100	56,5	M12X1,50	O-P4017CD		
				45	M5	4X100	56,5	M12X1,50	O-PN4517CD*		
				50	M5	4X100	56,5	M12X1,50	O-PN5017CD*		

*DIAMOND FINISH / Finitura diamantata • Available in one week / Disponibile in una settimana

FIAT

MODELLO / MODEL	ANNO / YEAR DA / START A / END	NOTA CHIAVE KEY NOTE	SPESSORE THICKNESS (mm)	TIPO TYPE	INTERASSE C TO C	Ø	FILETTO THREAD	CODICE CODE #	NOTE NOTES
Tipo Type 356 Doblo' Type 263/L 500L	2016 Jan/2010 Sept/2012	> > >	5	M1	5X98	58		0-P0504S	A-Y
			5	M2a	5X98	58	M12X1,25	0-P0504C7	B-Y
			5	M2a	5X98	58	M12X1,25	0-P05108C	C-Y
			12	M1	5X98	58		0-P1204S	
			12	M2a	5X98	58	M12X1,25	0-P1204C7	B
			12	M2a	5X98	58	M12X1,25	0-P12108C	C
			16	M1	5X98	58		0-P1604S	
			16	M2a	5X98	58	M12X1,25	0-P1604C7	B
			16	M2a	5X98	58	M12X1,25	0-P16108C	C
			20	M1	5X98	58		0-P2004S	
			20	M2a	5X98	58	M12X1,25	0-P2004C7	B
			20	M2a	5X98	58	M12X1,25	0-P20108C	C
			25	M5	5X98	58	M12X1,25	0-P2504CD	
			30	M5	5X98	58	M12X1,25	0-P3004CD	
			35	M5	5X98	58	M12X1,25	0-PN3504CD*	
			40	M5	5X98	58	M12X1,25	0-PN4004CD*	
45	M5	5X98	58	M12X1,25	0-PN4504CD*				
50	M5	5X98	58	M12X1,25	0-PN5004CD*				
500X Type 334	Sept/2014	>	5	M1	5X110	65		0-P0540S	A-Y
			5	M2a	5X110	65	M12X1,25	0-P05101C	B-Y
			5	M2a	5X110	65	M12X1,25	0-P05109C	C-Y
			17	M1	5X110	65		0-P1740S	
			17	M2a	5X110	65	M12X1,25	0-P17101C	B
			17	M2a	5X110	65	M12X1,25	0-P17109C	C
			20	M1	5X110	65		0-P2040S	
			20	M2a	5X110	65	M12X1,25	0-P20101C	B
			20	M2a	5X110	65	M12X1,25	0-P20109C	C
25	M5	5X110	65	M12X1,25	0-PN2542CD*				
Nuova Cromia Type 194	Sept/2005	Mar/2011	5	M1	5X110	65		0-P0540S	A-Y
			5	M2a	5X110	65	12X1,50	0-P0540C	Y
			17	M1	5X110	65		0-P1740S	
			17	M2a	5X110	65	12X1,50	0-P1740C	
			20	M1	5X110	65		0-P2040S	
			20	M2a	5X110	65	12X1,50	0-P2040C	
			30	M2a	5X110	65	12X1,50	0-PN3040CD*	
			35	M2a	5X110	65	12X1,50	0-PN3540CD*	
			40	M2a	5X110	65	12X1,50	0-PN4040CD*	
50	M2a	5X110	65	12X1,50	0-PN5040CD*				
Scudo I Type 220L / 220P Ulysse Type 179 / 220	Feb/1996 2002	Sep/2006 2010	5	M1	5X98	58		0-P0504S	A-Y
			5	M2a	5X98	58	14X150	0-P0549C	Y
			12	M1	5X98	58		0-P1204S	
			12	M2a	5X98	58	14X150	0-P1249C	
			16	M1	5X98	58		0-P1604S	
			16	M2a	5X98	58	14X150	0-P1649C	
			20	M1	5X98	58		0-PN2004S*	
			20	M1	5X98	58		0-P2004S	
			20	M2a	5X98	58	14X150	0-P2049C	
			30	M5	5X98	58	14X150	0-PN3049CD*	
			35	M5	5X98	58	14X150	0-PN3549CD*	

*DIAMOND FINISH / Finitura diamantata • Available in one week / Disponibile in una settimana

FIAT

MODELLO / MODEL	ANNO / YEAR DA / START A / END	NOTA CHIAVE KEY NOTE	SPESSORE THICKNESS (mm)	TIPO TYPE	INTERASSE C TO C	Ø	FILETTO THREAD	CODICE CODE #	NOTE NOTES	
Scudo II Kombi Type 270	2007	>	5	M1	5X108	65			O-P0531S	A-Y
			5	M2a	5X108	65	12X1,25		O-P0558C7	C-Y
			5	M3b	5X108	65	12X1,25		O-P0558CP7	S-Y
			12	M1	5X108	65			O-P1231S	
			12	M2a	5X108	65	12X1,25		O-P1258C7	C
			12	M3b	5X108	65	12X1,25		O-P1258CP7	S
			16	M1	5X108	65			O-P1631S	
			16	M2a	5X108	65	12X1,25		O-P1658C7	C
			16	M3b	5X108	65	12X1,25		O-P1658CP7	S
			20	M1	5X108	65			O-P2031S	
			20	M2a	5X108	65	12X1,25		O-P2058C7	C
			20	M3b	5X108	65	12X1,25		O-P2058CP7	S
			25	M5	5X108	65	12X1,25		O-PN2558CD*	
			35	M5	5X108	65	12X1,25		O-PN3558CD*	
50	M5	5X108	65	12X1,25		O-PN5058CD*				
Fiat Sedici Type FY	2005	>	16	M1	5X114,3	60			O-P1667S	
			16	M2a	5X114,3	60	12X1,50		O-P1668C	
			20	M1	5X114,3	60			O-P2067S	
			20	M2a	5X114,3	60	12X1,50		O-P2068C	
			30	M4	5X114,3	60	12X1,50		O-P3068CD	H
Freemont Type JC	June/2011	June/2015	25	M4	5X127	71,5	12X1,50		O-PFSF325	M
			30	M4	5X127	71,5	12X1,50		O-PFSF330	M
Ducato I Type 280, 280L, 280P, 290, 290L, 290P Ducato II Type 230*D/L/M/P, 244*B/D/L/M, 250*D/L/M Ducato III Type 250, 250D	1982	1994	5	M1	5X118	71	M14X1,5		O-PN05103S*	
	1994	2006	25	M5	5X118	71	M14X1,5		O-PN25103CD*	
	2006	>	30	M5	5X118	71	M14X1,5		O-PN30103CD*	

FIAT (Off-road)

Fullback Type KAOT	2016	>	30	M4	6X139,7	67	M12X1,50		O-PFSM330	M-H
			40	M5	6X139,7	67	M12X1,50		O-PNFSM340*	H
			50	M5	6X139,7	67	M12X1,50		O-PNFSM350*	H

FORD

MODELLO / MODEL	ANNO / YEAR DA / START A / END	NOTA CHIAVE KEY NOTE	SPESSORE THICKNESS (mm)	TIPO TYPE	INTERASSE C TO C	Ø	FILETTO THREAD	CODICE CODE #	NOTE NOTES			
B-MAX Type JK8 Capri Type I-II-III Ecosport Type JK8 Escort Cosworth Type ABLC4 Escort I-II Type ATH-BA-TN-GADR Escort III Type AVF-ANL-ALD Escort IV Type GAL-AAL-ABL-AFL Fiesta Type WFBT-GFBT-FBD-G009 Fiesta Type JAS - JBS Fiesta Type JA8 Fiesta Type JHH Focus I Type D Fusion Type JU Ka I Type RBT StreeKa Type RL2 Mondeo Type B Puma Type ECT Scorpio Sierra Type GBG / GB4 Sierra RS Cosworth Taunus Type GBS-GBN-K-GBTS	2012 2017 1968 1987 Oct/2013 > Feb/1995 Oct/1998 1968 1980 1985 1990 Oct/1990 Feb/1999 1976 1995 1995 Sept/2008 Oct/2008 2017 2017 > Oct/1998 Oct/2004 2002 Oct/2012 Sept/1996 Nov/2008 May/2003 July/2005 1993 2000 Mar/1997 June/2002 Apr/1985 Aug/1998 Aug/1982 Feb/1993 Jan/1987 Feb/1993 1975 1979		5	M1	4X108	63,3		0-P0512S	A-Y			
			12	M1	4x108	63,3			0-PN1212S*	D		
			12	M2b	4x108	63,3	M12X1,5		0-PN1212C*	D		
			16	M1	4X108	63,3			0-P1612S			
			16	M2b	4X108	63,3	M12X1,5		0-P1612C			
			20	M1	4X108	63,3			0-P2012S			
			20	M2b	4X108	63,3	M12X1,5		0-P2012C			
			20	M4	4X108	63,3	M12X1,5		0-P2012CD	M		
			25	M4	4X108	63,3	M12X1,5		0-P2512CD	M		
			27	M4	4X108	63,3	M12X1,5		0-PN2712CD*	M		
			30	M4	4X108	63,3	M12X1,5		0-P3012CD	M		
			35	M4	4X108	63,3	M12X1,5		0-PN3512CD*			
			40	M4	4X108	63,3	M12X1,5		0-PN4012CD*			
			45	M4	4X108	63,3	M12X1,5		0-PN4512CD*			
			48	M4	4X108	63,3	M12X1,5		0-PN4812CD*			
			50	M4	4X108	63,3	M12X1,5		0-PN5012CD*			
			60	M4	4X108	63,3	M12X1,5		0-PN6012CD*			
			Ka II Type RU8	2009 2016		5	M1	4X98	58		0-P0510S	A-Y
						5	M2a	4X98	58	M12X1,25		0-P0510C7
5	M2a	4X98				58	M12X1,25		0-P05105C	C-Y		
12	M1	4X98				58			0-P1210S			
12	M2a	4X98				58	M12X1,25		0-P1210C7	B		
12	M2a	4X98				58	M12X1,25		0-P12105C	C		
16	M1	4X98				58			0-P1610S			
16	M2a	4X98				58	M12X1,25		0-P1610C7	B		
16	M2a	4X98				58	M12X1,25		0-P16105C	C		
20	M1	4X98				58			0-P2010S			
20	M2a	4X98				58	M12X1,25		0-P2010C7	B		
20	M2a	4X98				58	M12X1,25		0-P20105C	C		
25	M5	4X98				58	M12X1,25		0-P2510CD			
30	M5	4X98				58	M12X1,25		0-P3010CD			
35	M5	4X98				58	M12X1,25		0-P3510CD			
40	M5	4X98				58	M12X1,25		0-P4010CD			
45	M5	4X98				58	M12X1,25		0-P4510CD			
50	M5	4X98	58	M12X1,25		0-P5010CD						

*DIAMOND FINISH / Finitura diamantata • Available in one week / Disponibile in una settimana

FORD

MODELLO / MODEL	ANNO / YEAR DA / START	A / END	NOTA CHIAVE KEY NOTE	SPESSORE THICKNESS (mm)	TIPO TYPE	INTERASSE C TO C	Ø	FILETTO THREAD	CODICE CODE #	NOTE NOTES
Focus II Type DA3 / DB3	2003	2010		5	M1	5X108	63,3		O-P0561S	A-Y
Focus III / RS Type DA3-RS	Sept/2008	Feb/2011		16	M1	5X108	63,3		O-P1661S	
Focus III / ST Type DYB	2011	2018		16	M2b	5X108	63,3	M12X1,50	O-P1661C	
Focus IV Type HN	Gen/2018	>		20	M1	5X108	63,3		O-P2061S	
Focus RS Type DYB	2016	2018		20	M2b	5X108	63,3	M12X1,50	O-P2061C	
C MAX Type DM2	2003	Oct/2010		20	M1	5X108	63,3		O-P2061S	
C MAX Type DXA	Nov/2010	>		20	M2b	5X108	63,3	M12X1,50	O-P2061C	
Grand C MAX Type DXA	Nov/2010	>		20	M4	5X108	63,3	M12X1,50	O-P2061CD	M
Kuga Type DM2	2008	>		25	M4	5X108	63,3	M12X1,50	O-P2561CD	M
Puma Type J2K	2019	>		30	M4	5X108	63,3	M12X1,50	O-P3061CD	M
Mustang Mach-E Type LSK	2020	>		30	M4	5X108	63,3	M12X1,50	O-P3061CD	M
Mondeo incl. Turnier Type B4Y/B5Y/BWY	1999	May/2007		35	M4	5x108	63,3	M12X1,50	O-PN3561CD*	
Mondeo incl. Turnier Type BA7/MK4	June/2007	2014		40	M4	5x108	63,3	M12X1,50	O-PN4061CD*	
Mondeo incl. Turnier Type BA7/MK5	2014	>		5	M1	5X112	57		O-P0506S	A-Y
Transit Type PT2 - PU2	2006	2013		5	M2a	5X112	57	M14X1,50	O-P0506C	Y
Transit Tourneo Connect Type PJ2-PH2	2002	>		12	M1	5X112	57		O-P1206S	
Windstar Type A3	1995	2003		12	M2a	5X112	57	M14X1,50	O-P1206C	
				16	M1	5X112	57		O-P1606S	
				16	M2a	5X112	57	M14X1,50	O-P1606C	
				20	M1	5X112	57		O-P2006S	
				20	M2a	5X112	57	M14X1,50	O-P2006C	
				25	M5	5X112	57	M14X1,50	O-P2506CD	
				30	M5	5X112	57	M14X1,50	O-P3006CD	
				35	M5	5X112	57	M14X1,50	O-P3506CD	
				40	M5	5X112	57	M14X1,50	O-P4006CD	
Galaxy Type WGR	1996	May/2006		20	M4	5X108	63,3	M14X1,50	O-P2087CD	M
				25	M4	5x108	63,3	M14X1,50	O-PN2587CD*	M
				30	M4	5X108	63,3	M14X1,50	O-P3087CD	M
Edge Type SBF	2015	>		5	M1	5X114,3	67		O-P0556S	A-Y
Galaxy III Type WA6/MK3	June/2006	2014		16	M1	5X114,3	67		O-P1656S	
Galaxy IV Type WA6/MK4	2015	>		16	M2b	5X114,3	67	M12X1,50	O-P1656C	L
S MAX Type WA6	June/2006	2014		16	M2b	5X114,3	67	M12X1,50	O-P1659C	R
S MAX II Type WA6 II	2015	>		20	M1	5X114,3	67		O-P2056S	
Tourneo Connect Type PJ2-PU2	2018	>		20	M2b	5X114,3	67	M12X1,50	O-P2056C	L
Transit Type FFD	2014	>		20	M2b	5X114,3	67	M12X1,50	O-P2059C	R
				20	M4	5X114,3	67	M12X1,50	O-P2056CD	M-H
				25	M4	5X114,3	67	M12X1,50	O-P2556CD	M-H
				30	M4	5X114,3	67	M12X1,50	O-P3056CD	M-H
Probe Type ECP	1988	1998		20	M4	5X114,3	70,3	1/2" UNF	O-PN20146CD*	NEW Z
Maverick Type 1N2 / 1N2R	2003	2008		30	M4	5X114,3	70,3	1/2" UNF	O-PN30146CD*	NEW Z
Escape Type 1N2 / 1N2R	2003	2008		20	M4	5X114,3	70,5	1/2" UNF	O-PN2081CD*	M-H
				25	M4	5X114,3	70,5	1/2" UNF	O-PN2581CD*	M-H
				30	M4	5X114,3	70,5	1/2" UNF	O-PN3081CD*	M-H
				40	M4	5X114,3	70,5	1/2" UNF	O-PN4081CD*	M-H
				50	M4	5X114,3	70,5	1/2" UNF	O-PN5081CD*	H
Mustang Mach 1	1971	1973								
Mustang		2014								

*DIAMOND FINISH / Finitura diamantata • Available in one week / Disponibile in una settimana

FORD

MODELLO / MODEL	ANNO / YEAR DA / START A / END	NOTA CHIAVE KEY NOTE	SPESSORE THICKNESS (mm)	TIPO TYPE	INTERASSE C TO C	Ø	FILETTO THREAD	CODICE CODE #	NOTE NOTES
Mustang Type VI - LAE	2014	>	20	M4	5X114,3	70,5	M14X1,50	0-PN20137CD*	M-H
			25	M4	5X114,3	70,5	M14X1,50	0-PN25137CD*	M-H
			30	M4	5X114,3	70,5	M14X1,50	0-PN30137CD*	M-H
			35	M4	5X114,3	70,5	M14X1,50	0-PN35137CD*	M-H
Transit Custom Type FAC/FCC	2012	up	30	M4	5x160	65,1	M14X1,50	0-PNFSF530*	M-H
			40	M4	5x160	65,1	M14X1,50	0-PNFSF540* NEW	M-H

FORD (Off-road)

Ranger Type AW2 Maverick Type UDS/UNS/R20	2003 1996	2006 1998	30	M4	6X139,7	108	M12X1,50	0-PFSM130	Y
			40	M4	6X139,7	108	M12X1,50	0-PNFSM140*	Y
			50	M4	6X139,7	108	M12X1,50	0-PNFSM150*	Y
			60	M4	6X139,7	108	M12X1,50	0-PNFSM160* NEW	Y
Ranger Type 2AB Ranger Raptor Type 2AB	2010 2019	> >	30	M4	6X139,7	93	M12X1,50	0-PFSF430	M-H
			35	M4	6X139,7	93	M12X1,50	0-PNFSF435*	H
F-150 Type MK13	2015	>	30	M4	6x135	87	M14X1,50	0-PNFSF630*	M-H
			50	M4	6x135	87	M14X1,50	0-PNFSF650* NEW	H

GREAT WALL MOTOR

MODELLO / MODEL	ANNO / YEAR DA / START A / END	NOTA CHIAVE KEY NOTE	SPESSORE THICKNESS (mm)	TIPO TYPE	INTERASSE C TO C	Ø	FILETTO THREAD	CODICE CODE #	NOTE NOTES
Hover 2 wd Type Hover Hover 4 wd Type Hover Steed 4 wd Type Hover	2005 2005 2009	> > >	30	M4	6X139,7	108	M12X1,25	0-PFSN130	M-Y
			35	M4	6X139,7	108	M12X1,25	0-PNFSN135*	Y
			40	M4	6X139,7	108	M12X1,25	0-PNFSN140*	Y

HONDA

MODELLO / MODEL	ANNO / YEAR DA / START A / END	NOTA CHIAVE KEY NOTE	SPESSORE THICKNESS (mm)	TIPO TYPE	INTERASSE C TO C	Ø	FILETTO THREAD	CODICE CODE #	NOTE NOTES
Accord SY Logo Type GA3 Civic III Type AG - AS Civic IV Type EC8 - EC9 - ED2-7 - EE2-9 Civic V Type EG3-9- EH6-9 -EJ1-EJ2-EG2 Civic VI Type EJ16-9 - EK1- 9 - EM1- KE8 Civic VII Type EP1-4 - EU5- 9 - EV1 - ES4-9 Concerto Type All Models Insight I Type ZE1 - ZE2 Insight II Type ZE2 Jazz I Type AA Jazz II Type GD1 - GD5 - GE2 - GE3 Jazz III Type GG1-6 - GE6 - GP1 - GK Jazz V Type GR Legend K3 Prelude SN/AB/BA2/BA4	Dec/1997	June/2003	5	M1	4X100	56		0-P0539S	A-Y
	Mar/1999	Mar/2002	12	M1	4X100	56		0-P1239S	
	1983	1987	12	M2b	4X100	56	M12X1,50	0-P1213C	O
	1987	1991	16	M1	4X100	56		0-P1639S	
	1991	1995	16	M2b	4X100	56	M12X1,50	0-P1613C	O
	1995	2001	20	M1	4X100	56		0-P2039S	
	2001	2006	20	M2b	4X100	56	M12X1,50	0-P2013C	O
	1991	1994	20	M4	4X100	56	M12X1,50	0-P2013CD	M
	1999	2006	25	M4	4X100	56	M12X1,50	0-PN2513CD*	M
	Apr/2009	>	30	M4	4X100	56	M12X1,50	0-PN3013CD*	M
	1983	1986	35	M4	4X100	56	M12X1,50	0-PN3513CD*	
	2001	2008	40	M4	4X100	56	M12X1,50	0-PN4013CD*	
	2015	>	50	M4	4X100	56	M12X1,50	0-PN5013CD*	
	2020	>							
	Oct/1987	Mar/1996							
	1978	1992							

*DIAMOND FINISH / Finitura diamantata • Available in one week / Disponibile in una settimana

HONDA

MODELLO / MODEL	ANNO / YEAR DA / START A / END	NOTA CHIAVE KEY NOTE	SPESSORE THICKNESS (mm)	TIPO TYPE	INTERASSE C TO C	Ø	FILETTO THREAD	CODICE CODE #	NOTE NOTES
Accord IV Type CB3-8, CC1, CC9	1989	1993	20	M1	4X114,3	64		0-PN2029S* NEW	
Accord V Type CC7, CD7, CD9, CE1-9;CF1	1994	1998	20	M4	4x114,3	64	M12x1,50	0-PN2029CD* NEW	
Accord VI Type CG2-9, CH1-8, CL3, CL4	1999	2002	30	M4	4x114,3	64	M12x1,50	0-PN3029CD*	
Civic Type MC2, MB6	1997	2001	35	M4	4x114,3	64	M12x1,50	0-PN3529CD NEW	
Legend Type KA4	1989	1991	40	M4	4X114,3	64	M12x1,50	0-PN4029CD NEW	
Legend Type KA3	1989	1991							
Prelude IV Type BB1	1992	1996							
Accord Type CL7-CN9-CN1-CM2-CM1	2008	2015	16	M1	5X114,3	64		0-P1608S	
Accord Type C	2003	2007	16	M2b	5X114,3	64	M12X1,50	0-P1608C	0
CR-V RD1/RD37/RD8	Dec/2001	2015							
Civic VI Aerodeck Type MB/MC	Apr/1998	Feb/2001	20	M1	5X114,3	64		0-P2008S	
Civic VII Hatchback Type EU/EP/EV	Jan/2000	Sept/2005							
CIVIC VIII Hatchback Type FN/FK	Sept/2005	2012	20	M2b	5X114,3	64	M12X1,50	0-P2008C	0
CIVIC IX Type FK	Feb/2012	>	20	M4	5X114,3	64	M12X1,50	0-P2008CD	M
CIVIC IX Tourer Type FK	Jan/2014	>							
CIVIC Type R (FN2)	2007	2010	25	M4	5X114,3	64	M12X1,50	0-PN2508CD*	M
CR-Z Type ZFI	June/2010	2013	30	M4	5X114,3	64	M12X1,50	0-P3008CD	M
E Type ZC7	2019	>							
FR-V Type BE1/BE3	Feb/2005	2009	35	M4	5X114,3	64	M12X1,50	0-PN3508CD*	
HR-V Type GH2	2000	2006							
Prelude BB6/BB8	1997	2003	40	M4	5X114,3	64	M12X1,50	0-PN4008CD*	
Stream Type RN1/RN3	May/2001	>							
Integra Coupe* Type DC2	July/1993	Nov/2001	50	M4	5X114,3	64	M12X1,50	0-PN5008CD*	
Integra Type R B632	Feb/2002	>							
S2000	1999	2009	20	M4	5x114,3	70	M12x1,5	0-PN2055CD*	M-H
NSX	1990	2002	35	M4	5x114,3	70	M12x1,5	0-PN3555CD*	M-H
			16	M1	5X114,3	64		0-P1608S	
			16	M2b	5X114,3	64	M12X1,50	0-P1608C	0
			20	M1	5X114,3	64		0-P2008S	
			20	M2b	5X114,3	64	M12X1,50	0-P2008C	0
S2000	1999	2009	20	M4	5X114,3	64	M12X1,50	0-P2008CD	M
NSX	1990	2002	25	M4	5X114,3	64	M12X1,50	0-PN2508CD*	M
			30	M4	5X114,3	64	M12X1,50	0-P3008CD	M
			35	M4	5X114,3	64	M12X1,50	0-PN3508CD*	
			40	M4	5X114,3	64	M12X1,50	0-PN4008CD*	
			50	M4	5X114,3	64	M12X1,50	0-PN5008CD*	
Civic Type R FK2	2015	2017	20	M4	5x120	64	M14x1,5	0-PN2021CD*	
Civic Type R FK8	2017	>							
Legend Type KB1	2006	2008							
Legend Type KB2	2008	2010	25	M4	5x120	64	M14x1,5	0-PN2521CD*	
Ridgeline	2005	>							

HYUNDAI

MODELLO / MODEL	ANNO / YEAR DA / START A / END	NOTA CHIAVE KEY NOTE	SPESSORE THICKNESS (mm)	TIPO TYPE	INTERASSE C TO C	Ø	FILETTO THREAD	CODICE CODE #	NOTE NOTES
Accent Type LC	Sept/1999	Oct/2002	5	M1	4X100	54		0-PN0514S*	
Atos Type MXI	Feb/1998	2008	16	M1	4X100	54		0-P1614S	
Accent Type MC/MCT	Apr/2006	2009	16	M2b	4X100	54	M12X1,50	0-P1614C	L
Getz Type TB	Sept/2002	2007	20	M1	4X100	54		0-P2014S	
Getz Type TBI	2007	>	20	M2b	4X100	54	M12X1,50	0-P2014C	L
i10 I Type PA	2008	2013	20	M4	4X100	54	M12X1,50	0-P2014CD	M
i10 II Type IA	2013	2019							
i10 III Type AC3	2019	>	30	M4	4X100	54	M12X1,50	0-PN3014CD*	M
i20 Type PB/PBT	2009	2014	35	M4	4X100	54	M12X1,50	0-PN3514CD*	
i20 Type GB	2014	>	40	M4	4X100	54	M12X1,50	0-PN4014CD*	
			50	M4	4X100	54	M12X1,50	0-PN5014CD*	

*DIAMOND FINISH / Finitura diamantata • Available in one week / Disponibile in una settimana

HYUNDAI

MODELLO / MODEL	ANNO / YEAR DA / START A / END	NOTA CHIAVE KEY NOTE	SPESSORE THICKNESS (mm)	TIPO TYPE	INTERASSE C TO C	Ø	FILETTO THREAD	CODICE CODE #	NOTE NOTES
Accent Type X-3 Atos Type MX / MXI Coupé / S.Coupé Type RD Lantra Type J-1/J-2/RD Matrix Type FC / FCT Pony Type X-2 Santamo Type M-200E Sonata Type EF	Oct/1994 Aug/1999 June/1996 Oct/1990 June/2001 Oct/1989 Oct/1991 Mar/1998	Jan/2000 2008 Apr/2001 Oct/2000 Dec/2005 Jan/1995 Dec/1998 May/2005	16	M1	4X114,3	67		0-P1611S	
			16	M2b	4X114,3	67	M12X1,50	0-P1611C	L
			20	M1	4X114,3	67		0-P2011S	
			20	M2b	4X114,3	67	M12X1,50	0-P2011C	L
			20	M4	4X114,3	67	M12X1,50	0-P2011CD	M
			25	M4	4X114,3	67	M12X1,50	0-PN2511CD*	M
			30	M4	4X114,3	67	M12X1,50	0-PN3011CD*	M
			35	M4	4X114,3	67	M12X1,50	0-PN3511CD*	
			40	M4	4X114,3	67	M12X1,50	0-PN4011CD*	
Ioniq Type AE Arnejs Type FD i30 I Incl. Kombi Type FD i30 II Type GDH/FDH i30 III Type PD/PDE i40 Type VF Coupé Type GK Genesis Coupé Type BK20/ BK38 Grandeur Type J XG25 / XG30 / XG35 Type XG Trajet Type FO Sonata Type NF Veloster Type FS iX35 Type EL-ELH iX55 Type EN Tucson Type JM Tucson Type TLE Santa Fè Type SM Santa Fè Type CM Santa Fè Type DM	2016 2007 July/2007 2011 2017 2017 2009 2002 Jan/2008 2005 2000 2000 2005 2011 2009 2008 2004 2015 Feb/2001 Jan/2006 2012	> > 2012 2017 > > 2009 > 2005 2005 2008 > 2016 > 2012 Mar/2010 > 2006 2009 2018	5	M1	5X114,3	67		0-P0556S	A-Y
			16	M1	5X114,3	67		0-P1656S	
			16	M2b	5X114,3	67	M12X1,50	0-P1656C	L
			16	M2b	5X114,3	67	M12X1,50	0-P1659C	R
			20	M1	5X114,3	67		0-P2056S	
			20	M2b	5X114,3	67	M12X1,50	0-P2056C	L
			20	M2b	5X114,3	67	M12X1,50	0-P2059C	R
			20	M4	5X114,3	67	M12X1,50	0-P2056CD	M-H
			25	M4	5X114,3	67	M12X1,50	0-P2556CD	M-H
			30	M4	5X114,3	67	M12X1,50	0-P3056CD	M-H
			35	M4	5X114,3	67	M12X1,50	0-PN3556CD*	H
			40	M4	5X114,3	67	M12X1,50	0-PN4056CD*	H
			45	M4	5X114,3	67	M12X1,50	0-PN4556CD* NEW	H
			50	M4	5X114,3	67	M12X1,50	0-PN5056CD*	H

HYUNDAI (Off-road)

Galloper Type JK - T01 Terracan Type HP	1991 2001	2003 Dec/2006		30	M4	6X139,7	108	M12X1,50	0-PFSM130	Y
--	--------------	------------------	--	----	----	---------	-----	----------	-----------	---

INFINITI

MODELLO / MODEL	ANNO / YEAR DA / START A / END	NOTA CHIAVE KEY NOTE	SPESSORE THICKNESS (mm)	TIPO TYPE	INTERASSE C TO C	Ø	FILETTO THREAD	CODICE CODE #	NOTE NOTES
EX35 Type EX35 EX 37 Type J50 FX35 Type FX S50 FX45 Type FX S51 G35 Coupé Type G35 G37 Type V36 Q60 Type V37 Q70 Type Y51 QX70 Type S51 M Type Y51	2007 2009 2003 2009 2003 2009 2016 2010 2013 Mar/2010	> > 2008 > 2006 > > > > >	5	M1	5X114,3	66		0-P0553S	A-Y
			16	M1	5X114,3	66		0-P1653S	
			16	M2b	5X114,3	66	M12X1,25	0-P1653C	I
			20	M1	5X114,3	66		0-P2053S	
			20	M2b	5X114,3	66	M12X1,25	0-P2053C	I
			20	M4	5X114,3	66	M12X1,25	0-P2053CD	M-H
			25	M4	5X114,3	66	M12X1,25	0-PN2553CD*	M-H
			30	M4	5X114,3	66	M12X1,25	0-P3053CD	M-H

ISUZU

MODELLO / MODEL	ANNO / YEAR DA / START A / END	NOTA CHIAVE KEY NOTE	SPESSORE THICKNESS (mm)	TIPO TYPE	INTERASSE C TO C	Ø	FILETTO THREAD	CODICE CODE #	NOTE NOTES
Campo Type KB	Apr/1977	Dec/1991	30	M4	6X139,7	108	M12X1,50	0-PFSM130	M-Y
D-MAX I Type 8DH	May/2002	2006	40	M4	6X139,7	108	M12X1,50	0-PNFSM140*	Y
D-MAX II Type TF	2006	2012	50	M4	6X139,7	108	M12X1,50	0-PNFSM150*	Y
D-MAX II Type TFR/TFS/ ATFR/ATFS	2012	Sept/2020	60	M4	6X139,7	108	M12X1,50	0-PNFSM160* NEW	Y
Trooper Type UB	Aug/1991	Apr/2000	30	M4	6x139.7	100		0-PNFSI130* NEW	M-H
D-MAX III Type N60	Oct / 2020	>							

JAGUAR

MODELLO / MODEL	ANNO / YEAR DA / START A / END	NOTA CHIAVE KEY NOTE	SPESSORE THICKNESS (mm)	TIPO TYPE	INTERASSE C TO C	Ø	FILETTO THREAD	CODICE CODE #	NOTE NOTES
F Type QQ6	2013	>	5	M1	5X108	63,3		0-P0561S	A-Y
XE Type JA	2015	>	16	M1	5X108	63,3		0-P1661S	
XK / XKR Type X150 -QQ6	2007	2014	20	M1	5X108	63,3		0-P2061S	
X Type Type CF1	2001	2009	16	M2b	5X108	63,3	M12X1,50	0-P1661C	R
XF Type CC9	2008	2015	20	M2b	5X108	63,3	M12X1,50	0-P2061C	R
XF Type JB	2016	>	20	M4	5X108	63,3	M12X1,50	0-P2061CD	M
XJ Type N3	2003	Feb/2010	25	M4	5X108	63,3	M12X1,50	0-P2561CD	M
S Type CCX	Apr/1999	Mar/2008	30	M4	5X108	63,3	M12X1,50	0-P3061CD	M
			35	M4	5X108	63,3	M12X1,50	0-PN3561CD*	
			40	M4	5X108	63,3	M12X1,50	0-PN4061CD*	
Daimler	1986	1994	20	M4	5x120,65	73,7	1/2" UNF	0-PN2066CD*	M
XJ	1994	1997	25	M4	5x120,65	73,7	1/2" UNF	0-PN2566CD*	M
XJ Daimler double six sovereign	1978	1992	30	M4	5x120,65	73,7	1/2" UNF	0-PN3066CD*	M
XJ8	1997	2003	35	M4	5x120,65	73,7	1/2" UNF	0-PN3566CD* NEW	
XJR	1997	2003	40	M4	5x120,65	73,7	1/2" UNF	0-PN4066CD*	
XJS Cabrio	1975	1996	50	M4	5x120,65	73,7	1/2" UNF	0-PN5066CD*	
XJS Coupe	1975	1996							
XK8	1996	2005							
XKR	1996	2005							
E-Pace Type all the models	2017	>	20	M4	5X108	63,3	M14X1,50	0-P2087CD	M
F-Pace Type DC - X761	2015	>	25	M4	5x108	63,3	M14X1,50	0-PN2587CD*	M
I-Pace Type X590	2019	>	30	M4	5X108	63,3	M14X1,50	0-P3087CD	M

*DIAMOND FINISH / Finitura diamantata • Available in one week / Disponibile in una settimana

JEEP

MODELLO / MODEL	ANNO / YEAR DA / START A / END	NOTA CHIAVE KEY NOTE	SPESSORE THICKNESS (mm)	TIPO TYPE	INTERASSE C TO C	Ø	FILETTO THREAD	CODICE CODE #	NOTE NOTES
Cherokee II Type Z / XJ Cherokee III Type KJ Cherokee IV Type KK Grand Cherokee I Wrangler II Type TJ - YJ	< 2001 Dec/2008 < 1997	2001 2007 Aug/2012 May/1999 Dec/2006	30	M4	5X114,3	71,5	1/2"UNF	0-PFSC130	H
			35	M4	5X114,3	71,5	1/2"UNF	0-PNFSC135*	H
			40	M4	5X114,3	71,5	1/2"UNF	0-PNFSC140*	H
			50	M4	5X114,3	71,5	1/2"UNF	0-PNFSC150* NEW	H
Cherokee V Type KL Renegade Type BU Compass II Type MX	Nov/2013 July/2014 2017	> > >	5	M2a	5X110	65	M12X1,25	0-P0542C	Y
			17	M2a	5X110	65	M12X1,25	0-P1742C	H
			20	M2a	5X110	65	M12X1,25	0-P2042C	H
			20	M5	5X110	65	M12X1,25	0-PN2042CD*	
			25	M5	5X110	65	M12X1,25	0-PN2542CD*	
			30	M5	5X110	65	M12X1,25	0-PN3042CD*	
Commander Type VH Gladiator Type JK Grand Cherokee II Type WJ Grand Cherokee III Type WG-WH Wrangler III Type JK	2006 2020 June/1999 June/2005 May/2007	2010 > 2004 2010 >	30	M4	5X127	71,5	1/2"UNF	0-PFSC330	H
			35	M4	5X127	71,5	1/2"UNF	0-PNFSC335*	H
			40	M4	5X127	71,5	1/2"UNF	0-PNFSC340*	H
CJ Type 5 / 7 / 8	Jan/1966	Dec/1987	30	M4	5X139	108	1/2"UNF	0-PFSJ130	M-Y
			40	M4	5x139	108	1/2"UNF	0-PNFSJ140*	Y
Patriot Type PK Compass I Type PK	Mar/2007 Nov/2006	2016 2017	20	M4	5X114,3	67	M12X1,50	0-P2056CD	M-H
			25	M4	5X114,3	67	M12X1,50	0-P2556CD	M-H
			30	M4	5X114,3	67	M12X1,50	0-P3056CD	M-H
			35	M4	5X114,3	67	M12X1,50	0-PN3556CD*	M-H
			40	M4	5X114,3	67	M12X1,50	0-PN4056CD*	M-H
			50	M4	5X114,3	67	M12X1,50	0-PN5056CD*	M-H
Grand Cherokee IV Type WK Wrangler IV Type JL	Nov/2010 2018	> >	25	M4	5X127	71,5	M14X1,50	0-PNFSJ225* NEW	M-H
			30	M4	5X127	71,5	M14X1,50	0-PFSJ230	M-H
			40	M4	5X127	71,5	M14X1,50	0-PNFSJ240* NEW	M-H

KIA

MODELLO / MODEL	ANNO / YEAR DA / START A / END	NOTA CHIAVE KEY NOTE	SPESSORE THICKNESS (mm)	TIPO TYPE	INTERASSE C TO C	Ø	FILETTO THREAD	CODICE CODE #	NOTE NOTES
Picanto I Type BA Picanto II Type TA Picanto III Type JA Rio I Type DC Rio II Type DE - JB Rio III Type UB Rio IV Type YB - SC Stonic Type YB	2004 2012 2017 2000 2005 2005 Sept/2011 2017 2017	2011 2017 > 2005 2011 2017 > >	5	M1	4X100	54		0-PN0514S*	
			16	M1	4x100	54		0-P1614S	
			16	M2b	4x100	54	M12X1,50	0-P1614C	L
			20	M1	4x100	54		0-P2014S	
			20	M2b	4x100	54	M12X1,50	0-P2014C	L
			20	M4	4x100	54	M12X1,50	0-P2014CD	M
			30	M4	4x100	54	M12X1,50	0-PN3014CD*	M
			35	M4	4x100	54	M12X1,50	0-PN3514CD*	
			40	M4	4x100	54	M12X1,50	0-PN4014CD*	
			50	M4	4x100	54	M12X1,50	0-PN5014CD*	
Mentor Type FB Sephia Type FA Shuma Type FB	1994 1995 1994	1999 1999 1999	5	M1	4x100	56		0-P0539S	A-Y
			16	M1	4x100	56		0-P1639S	
			16	M2b	4x100	56	M12X1,50	0-P16113C	L
			20	M1	4x100	56		0-P2039S	
			20	M2b	4x100	56	M12X1,50	0-P20113C	L
			20	M4	4x100	56	M12X1,50	0-P2013CD	M

*DIAMOND FINISH / Finitura diamantata • Available in one week / Disponibile in una settimana

KIA

MODELLO / MODEL	ANNO / YEAR DA / START	A / END	NOTA CHIAVE KEY NOTE	SPESSORE THICKNESS (mm)	TIPO TYPE	INTERASSE C TO C	Ø	FILETTO THREAD	CODICE CODE #	NOTE NOTES
Cerato Type FE Clarus Type GC Credos Type GC Joice I Magentis I Type GD Optima I Type GD	2004 1996 1996 1999 2001 2001	2008 2001 2001 2002 2005 2006		16	M1	4x114,3	67		0-P1611S	
				16	M2b	4x114,3	67	M12X1,50	0-P1611C	L
				20	M1	4x114,3	67		0-P2011S	
				20	M2b	4x114,3	67	M12X1,50	0-P2011C	L
				20	M4	4x114,3	67	M12X1,50	0-P2011CD	M
				30	M4	4x114,3	67	M12X1,50	0-PN3011CD*	M
				35	M4	4x114,3	67	M12X1,50	0-PN3511CD*	
				40	M4	4x114,3	67	M12X1,50	0-PN4011CD*	
Niro Type DE Optima II Type TF-E Optima III Type JF Ceed I Type ED Ceed II Type JD Ceed III Type CD Pro Ceed I Type ED Pro Ceed II Type JD Pro Ceed III Type CD Magentis II Type MG-GE Carens III Type FG Carens IV Type RP Opirus Type LD Stinger Type CK Soul Type AM Venga Type YN Carnival Type UP Sorento II Type XM Sorento III Type XM-FL Sportage II Type JE - JES Sportage III Type SLS Sportage V Type QL -QLE	2016 Aug/2012 2015 Dec/2006 June/2012 2018 Dec/2006 June/2012 2018 2005 Dec/2006 2013 2003 2017 2009 Feb/2010 1999 Oct/2009 Oct/2012 2004 Sept/2010 2016	> 2015 > July/2012 2018 > July/2012 2018 > 2010 Dec/2012 > Dec/2008 > 2013 > May/2006 Sept/2012 > Aug/2010 2015 >		5	M1	5x114,3	67		0-P0556S	A-Y
				16	M1	5x114,3	67		0-P1656S	
				16	M2b	5x114,3	67	M12X1,50	0-P1656C	L
				16	M2b	5x114,3	67	M12X1,50	0-P1659C	R
				20	M1	5x114,3	67		0-P2056S	
				20	M2b	5x114,3	67	M12X1,50	0-P2056C	L
				20	M2b	5x114,3	67	M12X1,50	0-P2059C	R
				20	M4	5x114,3	67	M12X1,50	0-P2056CD	M-H
				25	M4	5x114,3	67	M12X1,50	0-P2556CD	M-H
				30	M4	5x114,3	67	M12X1,50	0-P3056CD	M-H
				35	M4	5x114,3	67	M12X1,50	0-PN3556CD*	M-H
				40	M4	5x114,3	67	M12X1,50	0-PN4056CD*	H
				45	M4	5x114,3	67	M12X1,50	0-PN4556CD* NEW	H
				50	M4	5x114,3	67	M12X1,50	0-PN5056CD*	H

KIA (Off-road)

Sorento I Type JC	2002	Sept/2009		30	M4	5x139,7		M12X1,50	0-PFSK330	H
Rocsta Type CA Sportage I Type JA	1990 1994	1999 2004		30	M4	5x139,7	108	M12X1,50	0-PFSD130	Y
				40	M4	5x139,7	108	M12X1,50	0-PNFSD140*	Y

LAMBORGHINI

MODELLO / MODEL	ANNO / YEAR DA / START	A / END	NOTA CHIAVE KEY NOTE	SPESSORE THICKNESS (mm)	TIPO TYPE	INTERASSE C TO C	Ø	FILETTO THREAD	CODICE CODE #	NOTE NOTES
Gallardo Type 140	Mar/2003	>		5	M1	5x112	57		0-P0506S	A-Y
				5	M2a	5x112	57	M14X1,50	0-P0506C	B-Y
				12	M1	5x112	57		0-P1206S	
				12	M2a	5x112	57	M14X1,50	0-P1206C	B
				16	M1	5x112	57		0-P1606S	
				16	M2a	5x112	57	M14X1,50	0-P1606C	B
				20	M1	5x112	57		0-P2006S	
				20	M2a	5x112	57	M14X1,50	0-P2006C	B
				25	M5	5x112	57	M14X1,50	0-P2506CD	
				30	M5	5x112	57	M14X1,50	0-P3006CD	
				40	M5	5x112	57	M14X1,50	0-P4006CD	

LANCIA

MODELLO / MODEL	ANNO / YEAR DA / START A / END	NOTA CHIAVE KEY NOTE	SPESSORE THICKNESS (mm)	TIPO TYPE	INTERASSE C TO C	Ø	FILETTO THREAD	CODICE CODE #	NOTE NOTES
Y10 Y 840 Dedra 835 Prisma Thema 834	1985 1995 1994 1983 1984	1994 2003 1999 1992 1994	5	M1	4x98	58		O-P0510S	A-Y
			5	M2a	4x98	58	M12X1,25	O-P0510C	Y
			12	M1	4x98	58		O-P1210S	
			12	M2a	4x98	58	M12X1,25	O-P1210C	
			16	M1	4x98	58		O-P1610S	
			16	M2a	4x98	58	M12X1,25	O-P1610C	
			20	M1	4x98	58		O-P2010S	
			20	M2a	4x98	58	M12X1,25	O-P2010C	
			25	M5	4x98	58	M12X1,25	O-P2510CD	
			30	M5	4x98	58	M12X1,25	O-P3010CD	
			35	M5	4x98	58	M12X1,25	O-P3510CD	
			40	M5	4x98	58	M12X1,25	O-P4010CD	
			45	M5	4x98	58	M12X1,25	O-P4510CD	
			50	M5	4x98	58	M12X1,25	O-P5010CD	
Delta I 831 excl. Integrale/Evoluzione Delta II 836	Sept/1979 June/1993	Jan/1994 Sept/1999	5	M1	4x98	58	M12X1,25	O-P0510S	A-Y
			5	M2a	4x98	58	M12X1,25	O-P05118C	Y
			12	M1	4x98	58	M12X1,25	O-P1210S	
			12	M2a	4x98	58	M12X1,25	O-P12118C	
			16	M1	4x98	58	M12X1,25	O-P1610S	
			16	M2a	4x98	58	M12X1,25	O-P16118C	
			20	M1	4x98	58	M12X1,25	O-P2010S	
			20	M2a	4x98	58	M12X1,25	O-P20118C	
			25	M5	4x98	58	M12X1,25	O-P2510CD	
			30	M5	4x98	58	M12X1,25	O-P3010CD	
			35	M5	4x98	58	M12X1,25	O-P3510CD	
			40	M5	4x98	58	M12X1,25	O-P4010CD	
			45	M5	4x98	58	M12X1,25	O-P4510CD	
			50	M5	4x98	58	M12X1,25	O-P5010CD	
Ypsilon 843 Ypsilon 846 Lybra 839 Delta III 844 Musa 350	2003 June/2011 1999 Sept/2008 2004	2010 > 2006 > >	5	M1	4x98	58		O-P0510S	A-Y
			5	M2a	4x98	58	M12X1,25	O-P0510C7	B-Y
			5	M2a	4x98	58	M12X1,25	O-P05105C	C-Y
			12	M1	4x98	58		O-P1210S	
			12	M2a	4x98	58	M12X1,25	O-P1210C7	B
			12	M2a	4x98	58	M12X1,25	O-P12105C	C
			16	M1	4x98	58		O-P1610S	
			16	M2a	4x98	58	M12X1,25	O-P1610C7	B
			16	M2a	4x98	58	M12X1,25	O-P16105C	C
			20	M1	4x98	58		O-P2010S	
			20	M2a	4x98	58	M12X1,25	O-P2010C7	B
			20	M2a	4x98	58	M12X1,25	O-P20105C	C
			25	M5	4x98	58	M12X1,25	O-P2510CD	
			30	M5	4x98	58	M12X1,25	O-P3010CD	
			35	M5	4x98	58	M12X1,25	O-P3510CD	
			40	M5	4x98	58	M12X1,25	O-P4010CD	
			45	M5	4x98	58	M12X1,25	O-P4510CD	
50	M5	4x98	58	M12X1,25	O-P5010CD				

*DIAMOND FINISH / Finitura diamantata • Available in one week / Disponibile in una settimana

LANCIA

MODELLO / MODEL	ANNO / YEAR DA / START A / END		NOTA CHIAVE KEY NOTE	SPESSORE THICKNESS (mm)	TIPO TYPE	INTERASSE C TO C	Ø	FILETTO THREAD	CODICE CODE #	NOTE NOTES
Delta 831 Integrale / Evoluzione	1991	1995		5	M1	5x98	58		0-P0504S	A-Y
				5	M2a	5x98	58	M12X1,25	0-P05107C	Y
				12	M1	5x98	58		0-P1204S	
				12	M2a	5x98	58	M12X1,25	0-P12107C	
				16	M1	5x98	58		0-P1604S	
				16	M2a	5x98	58	M12X1,25	0-P16107C	
				20	M1	5x98	58		0-P2004S	
				20	M2a	5x98	58	M12X1,25	0-P20107C	
				25	M5	5x98	58	M12X1,25	0-P2504CD	
				30	M5	5x98	58	M12X1,25	0-P3004CD	
				35	M5	5X98	58	M12X1,25	0-PN3504CD*	
				40	M5	5X98	58	M12X1,25	0-PN4004CD*	
				45	M5	5X98	58	M12X1,25	0-PN4504CD*	
50	M5	5X98	58	M12X1,25	0-PN50004CD*					
Phedra 179 Z 220	2002 May/1995	2010 Sept/2002		5	M1	5x98	58		0-P0504S	A-Y
				5	M2a	5x98	58	M14X1,50	0-P0549C	Y
				12	M1	5x98	58		0-P1204S	
				12	M2a	5x98	58	M14X1,50	0-P1249C	
				16	M1	5x98	58		0-P1604S	
				16	M2a	5x98	58	M14X1,50	0-P1649C	
				20	M1	5x98	58		0-P2004S	
				20	M2a	5x98	58	M14X1,50	0-P2049C	
K 838 Thesis 841	Aug/1994 July/2002	Oct/2001 2009		12	M1	5x108	58		0-P1202S	
				12	M2a	5x108	58	M12X1,25	0-P1202C	B
				12	M2a	5x108	58	M12X1,25	0-P12110C	C
				16	M1	5x108	58		0-P1602S	
				16	M2a	5x108	58	M12X1,25	0-P1602C	B
				16	M2a	5x108	58	M12X1,25	0-P16110C	C
				20	M1	5x108	58		0-P2002S	
				20	M2a	5x108	58	M12X1,25	0-P2002C	B
				20	M2a	5x108	58	M12X1,25	0-P20110C	C
Thema Type LX	Sept/2011	>		20	M4	5x115	71,5	M14X1,50	0-P2072CD	M
				25	M4	5x115	71,5	M14X1,50	0-P2572CD	M
				30	M4	5x115	71,5	M14X1,50	0-PN3072CD*	M
Voyager Type RT	nov-11	>		30	M4	5X127	71,5	M12X1,50	0-PFSF330	H

*DIAMOND FINISH / Finitura diamantata • Available in one week / Disponibile in una settimana

LAND ROVER (Off-road)

MODELLO / MODEL	ANNO / YEAR DA / START A / END	NOTA CHIAVE KEY NOTE	SPESSORE THICKNESS (mm)	TIPO TYPE	INTERASSE C TO C	Ø	FILETTO THREAD	CODICE CODE #	NOTE NOTES	
Discovery II Type LT/LTD Range Rover II Type LP/LPD	1998 1994	2004 2001	30	M4	5X120	70	M14X1,50	0-PFSL130	H	
Defender 90 - 110 Type LD Discovery I Type SALL J6 Range Rover I	1990 Sept/1989 July/1970	2016 June/1998 July/1994	30	M4	5X165	116	M16X1,50	0-PFSL330	Y	
			35	M4	5X165	116	M16X1,50	0-PNFSL335*	NEW	Y
			40	M4	5X165	116	M16X1,50	0-PNFSL340*		Y
Freelander I Type LN / LND	1997	2006	20	M4	5X114,3	64	M12X1,50	0-P2008CD	M-H	
			30	M4	5X114,3	64	M12X1,50	0-P3008CD		M-H
Defender Type L663 Discovery III Type LA Discovery IV Type LA Discovery V Type LR Range Rover III Type LM/L322 Range Rover IV Type LG/L405 Range Rover Sport/SVR Type LS Range Rover Sport/SVR Type LW	2020 Oct/2004 Apr/2009 2017 Mar/2002 Aug/2012 Feb/2005 Apr/2013	> Mar/2009 2016 > Aug/2012 > Mar/2013 >	20	M4	5X120	72,5	M14X1,50	0-PFSL420	M-H	
			25	M4	5X120	72,5	M14X1,50	0-PFSL425	M-H	
			30	M4	5X120	72,5	M14X1,50	0-PFSL430	M-H	
			35	M4	5X120	72,5	M14X1,50	0-PNFSL435*	H	
			40	M4	5X120	72,5	M14X1,50	0-PNFSL440*	H	
			Discovery Sport Type LC Freelander II Type LF Evoque Type LV Evoque Type L551 Velar Type L560	Sept/2015 Jan/2007 June/2011 2019 2017	> 2014 2018 > >	20	M4	5X108	63,3	M14X1,50
25	M4	5X108				63,3	M14X1,50	0-PN2587CD*	M-H	
30	M4	5X108				63,3	M14X1,50	0-P3087CD	M-H	

LEXUS

MODELLO / MODEL	ANNO / YEAR DA / START A / END	NOTA CHIAVE KEY NOTE	SPESSORE THICKNESS (mm)	TIPO TYPE	INTERASSE C TO C	Ø	FILETTO THREAD	CODICE CODE #	NOTE NOTES
CT 200H Type A10a	2010	>	16	M1	5X100	54		0-P1615S	
			16	M2b	5X100	54	M12X1,50	0-P1615C	L
			20	M1	5X100	54		0-P2015S	
			20	M2b	5X100	54	M12X1,50	0-P2015C	L
			20	M4	5X100	54	M12X1,50	0-P2015CD	M
IS220 / IS250 Type XE2A IS200 / IS300 / Sport Cross Type XE1 RX300 Type XU3A RX 300 Type XU1 RX 350 Type XU3A RX 400 Type HXU3(A) GS 300 Type S19A GS 300 Type S16 GS 430 Type S19A GS 450 Type HS19A SC 430 Type Z4 GS 460 Type S19A LS 430 Type F3 NX Type AZ1	2005 1998 2004 2000 2004 June/2005 2005 1998 2005 2005 2007 2000 2007 2000 2014	> 2004 2006 2003 2009 > > 2012 2005 2012 > 2006 > > >	16	M1	5X114,3	60		0-P1667S	
			16	M2b	5X114,3	60	M12X1,50	0-P1667C	L
			20	M1	5X114,3	60		0-P2067S	
			20	M2b	5X114,3	60	M12X1,50	0-P2067C	L
			20	M4	5X114,3	60	M12X1,50	0-P2067CD	M
			25	M4	5X114,3	60	M12X1,50	0-PN2567CD*	M
			30	M4	5X114,3	60	M12X1,50	0-P3067CD	M
			35	M4	5X114,3	60	M12X1,50	0-PN3567CD*	
			40	M4	5X114,3	60	M12X1,50	0-PN4067CD*	
			50	M4	5X114,3	60	M12X1,50	0-PN5067CD*	
			55	M4	5X114,3	60	M12X1,50	0-PN5567CD*	
			65	M4	5X114,3	60	M12X1,50	0-PN6567CD*	
			70	M4	5X114,3	60	M12X1,50	0-PN7067CD*	

LOTUS

MODELLO / MODEL	ANNO / YEAR DA / START A / END	NOTA CHIAVE KEY NOTE	SPESSORE THICKNESS (mm)	TIPO TYPE	INTERASSE C TO C	Ø	FILETTO THREAD	CODICE CODE #	NOTE NOTES	
ELISE II Serie 2 (S2) ELISE III Serie 3 (S3)	2000 2010	2010 >	5	M1	4X100	56,5			O-P0517S	A-Y
			5	M2a	4X100	56,5	M12X1,50		O-P0517C	B-Y
			17	M1	4X100	56,5			O-P1717S	
			17	M2a	4X100	56,5	M12X1,50		O-P1717C	B
			20	M1	4X100	56,5			O-P2017S	
			20	M2a	4X100	56,5	M12X1,50		O-P2017C	B
			25	M5	4X100	56,5	M12X1,50		O-P2517CD	
			30	M5	4X100	56,5	M12X1,50		O-P3017CD	
			35	M5	4X100	56,5	M12X1,50		O-P3517CD	
			40	M5	4X100	56,5	M12X1,50		O-P4017CD	
			45	M5	4X100	56,5	M12X1,50		O-PN4517CD*	
			50	M5	4X100	56,5	M12X1,50		O-PN5017CD*	
ELISE I Serie 1 (S1) EXIGE I Gen (S1)	1996 2000	2000 2001	16	M1	4x95,25	56,7			O-PN1630S*	
			20	M4	4x95,25	56,7	M12X1,50		O-PN2030CD*	M
			25	M4	4x95,25	56,7	M12X1,50		O-PN2530CD*	M
			40	M4	4x95,25	56,7	M12X1,50		O-PN4030CD*	M
EXIGE II Gen Omega Type Omega A	2004 1991	2011 >	5	M1	5X110	65			O-P0540S	A-Y
			5	M2a	5X110	65	M12X1,50		O-P0540C	Y
			17	M1	5X110	65			O-P1740S	
			17	M2a	5X110	65	M12X1,50		O-P1740C	
			20	M1	5X110	65			O-P2040S	
			20	M2a	5X110	65	M12X1,50		O-P2040C	
			30	M5	5X110	65	M12X1,50		O-PN3040CD*	
			35	M5	5X110	65	M12X1,50		O-PN3540CD*	
			40	M5	5X110	65	M12X1,50		O-PN4040CD*	
50	M5	5X110	65	M12X1,50		O-PN5040CD*				

MASERATI

MODELLO / MODEL	ANNO / YEAR DA / START A / END	NOTA CHIAVE KEY NOTE	SPESSORE THICKNESS (mm)	TIPO TYPE	INTERASSE C TO C	Ø	FILETTO THREAD	CODICE CODE #	NOTE NOTES	
3200 GT all models. Type 338B32	Oct/1998	Mar/2002	12-13	16	M2a	5X108	67	M14X1,50	O-P1644C	K
				16	M2a	5X108	67	M14X1,50	O-P16119C	V
				20	M2a	5X108	67	M14X1,50	O-P2044C	J
				20	M2a	5X108	67	M14X1,50	O-P20119C	K
				20	M4	5X108	67	M14X1,50	O-PN2044CD*	
				30	M4	5X108	67	M14X1,50	O-PN3044CD*	
4200 GT all models Type M138 4200 Spider all models Type M138	Mar/2002 Oct/2001	2007 2007	12-13 12-13	16	M2a	5X108	67	M14X1,50	O-P16122C	X
				16	M2a	5X108	67	M14X1,50	O-P16123C	V
				20	M2a	5X108	67	M14X1,50	O-P20122C	W
				20	M2a	5X108	67	M14X1,50	O-P20123C	K
				20	M4	5X108	67	M14X1,50	O-PN2044CD*	
				30	M4	5X108	67	M14X1,50	O-PN3044CD*	

*DIAMOND FINISH / Finitura diamantata • Available in one week / Disponibile in una settimana

MASERATI

MODELLO / MODEL	ANNO / YEAR DA / START A / END	NOTA CHIAVE KEY NOTE	SPESSORE THICKNESS (mm)	TIPO TYPE	INTERASSE C TO C	Ø	FILETTO THREAD	CODICE CODE #	NOTE NOTES
Quattroporte Gran Turismo Type 139 Gran Turismo GT Type M145	2004 2012	12-13	16	M2a	5x114	67	M14X1,50	0-P16124C	X
			16	M2a	5x114	67	M14X1,50	0-P16120C	V
	16		M2a	5x114	67	M14X1,50	0-P16121C	K	
	20		M2a	5x114	67	M14X1,50	0-P20124C	W	
	20		M2a	5x114	67	M14X1,50	0-P20120C	K	
	20		M2a	5x114	67	M14X1,50	0-P20121C	J	
	20		M5	5x114	67	M14x1,50	0-PN20120CD*		
	25		M4	5x114	67	M14X1,50	0-PN25120CD*		
Ghibli Type M157 Levante Type M161 Quattroporte Type 156	2013 2016 2013	> > >	30	M4	5x114	67	M14X1,50	0-PN30120CD*	
			16	M2a	5x114	67	M14X1,50	0-P1680C	NEW
			20	M2a	5x114	67	M14X1,50	0-P2080C	NEW
			20	M5	5x114	67	M14x1,50	0-PN20120CD*	
			25	M4	5x114	67	M14X1,50	0-PN25120CD*	
			30	M4	5x114	67	M14X1,50	0-PN30120CD*	
			45	M5	5X114	67	M14x1,50	0-PN45120CD*	NEW
50	M5	5X114	67	M14x1,50	0-PN50120CD*	NEW			

MAZDA

MODELLO / MODEL	ANNO / YEAR DA / START A / END	NOTA CHIAVE KEY NOTE	SPESSORE THICKNESS (mm)	TIPO TYPE	INTERASSE C TO C	Ø	FILETTO THREAD	CODICE CODE #	NOTE NOTES
Mazda 2 Type DY B561 121 Type JASM / JBSM	2003 1996	Oct/2007 2001	5	M1	4X108	63,3		0-P0512S	A-Y
			12	M1	4X108	63,3		0-PN1212S*	
			12		4X108	63,3		0-PN1212C*	
			16	M1	4X108	63,3		0-P1612S	
			16	M2b	4X108	63,3	M12X1,50	0-P1612C	
			20	M1	4X108	63,3		0-P2012S	
			20	M2b	4X108	63,3	M12X1,50	0-P2012C	
			20	M4	4X108	63,3	M12X1,50	0-P2012CD	M
			25	M4	4X108	63,3	M12X1,50	0-P2512CD	M
			27	M4	4X108	63,3	M12X1,50	0-PN2712CD*	M
			30	M4	4X108	63,3	M12X1,50	0-P3012CD	M
			35	M4	4X108	63,3	M12X1,50	0-PN3512CD*	
			40	M4	4X108	63,3	M12X1,50	0-PN4012CD*	
			45	M4	4X108	63,3	M12X1,50	0-PN4512CD*	
			48	M4	4X108	63,3	M12X1,50	0-PN4812CD*	
Mazda Miata	1989	1997	50	M4	4X108	63,3	M12X1,50	0-PN5012CD*	
			60	M4	4X108	63,3	M12X1,50	0-PN6012CD*	
			5	M1	4X100	54		0-PN0514S*	
			16	M1	4X100	54		0-P1614S	
			20	M1	4X100	54		0-P2014S	
			20	M4	4X100	54	M12X1,50	0-P2014CD	M
			30	M4	4X100	54	M12X1,50	0-PN3014CD*	M
			35	M4	4X100	54	M12X1,50	0-PN3514CD*	
40	M4	4X100	54	M12X1,50	0-PN4014CD*				
50	M4	4X100	54	M12X1,50	0-PN5014CD*				

*DIAMOND FINISH / Finitura diamantata • Available in one week / Disponibile in una settimana

MAZDA

MODELLO / MODEL	ANNO / YEAR DA / START	YEAR A / END	NOTA CHIAVE KEY NOTE	SPESSORE THICKNESS (mm)	TIPO TYPE	INTERASSE C TO C	Ø	FILETTO THREAD	CODICE CODE #	NOTE NOTES				
Mazda 2 Type DE - DE1 Mazda 2 Type DL - DJ 323 BJ / 323F Type BJ 323 Type BA MX3 Type EC MX5 Type NB MX5 Type NA MX5 Type ND Demio Type DW 121 Type DB	Oct/2007 2014 > 1998 2003 1994 1998 1991 1998 1998 2005 1989 1998 2015 > 2000 2003 Nov/1990	2014 > 2003 1998 1998 2005 1998 > 2003 Mar/1996		5	M1	4X100	54		O-PN0514S*					
				16	M1	4X100	54		O-P1614S					
				16	M2b	4X100	54	M12X1,50	O-P1614C	L				
				20	M1	4X100	54		O-P2014S					
				20	M2b	4X100	54	M12X1,50	O-P2014C	L				
				20	M4	4X100	54	M12X1,50	O-P2014CD	M				
				30	M4	4X100	54	M12X1,50	O-PN3014CD*	M				
				35	M4	4X100	54	M12X1,50	O-PN3514CD*					
				40	M4	4X100	54	M12X1,50	O-PN4014CD*					
				50	M4	4X100	54	M12X1,50	O-PN5014CD*					
				3 Type BK 3 Type BL 3 Type BM 3 Type BP 5 Type CR1 5 Type CW 6 Type G 6 Type GH 6 Type GJ 323F V6 Type BA 626 Type G CX-3 Type DJ1 CX-5 Type KE - GH CX-5 Type KF CX-30 Type DM CX-9 Type TB1 CX-9 Type CX - 7 Type ER RX 7 Type FD RX 8 Type SE Xsedos 6 Type CA MX-5 Type NC1E MX-6 Type GE6 MX-30 Type DR MPV Type LV Xsedos 9 Type TA Premacy Type CP/CPD Tribute Type EP	Apr/2003 2009 2013 2018 2019 > 2001 2010 2010 > 2002 2007 Jan/2008 2010 > 1994 2000 1994 2001 2015 > 2011 2016 2016 > 2019 > 2007 2015 > Oct/2007 2012 July/1992 2002 2003 1992 1999 2005 2015 1987 1997 2020 > Aug/1999 2006 July/1993 2002 1996 2001 1993 2002	Mar/2009 2013 2018 > 2010 > 2007 2010 > 2000 2001 > 2016 > > 2015 > 2012 2002 2012 1999 2015 1997 > 2006 2002 2001 2002		5	M1	5X114,3	67		O-P0556S	A-Y
12	M1	5X114,3	67						O-PN1256S*					
14	M1	5X114,3	67						O-PN1456S*					
16	M1	5X114,3	67						O-P1656S					
16	M2b	5X114,3	67					M12X1,50	O-P1656C	L				
16	M2b	5X114,3	67					M12X1,50	O-P1659C	R				
20	M1	5X114,3	67						O-P2056S					
20	M2b	5X114,3	67					M12X1,50	O-P2056C	L				
20	M2b	5X114,3	67					M12X1,50	O-P2059C	R				
20	M4	5X114,3	67					M12X1,50	O-P2056CD	M-H				
25	M4	5X114,3	67					M12X1,50	O-P2556CD	M-H				
30	M4	5X114,3	67					M12X1,50	O-P3056CD	M-H				
35	M4	5X114,3	67					M12X1,50	O-PN3556CD*	H				
40	M4	5X114,3	67					M12X1,50	O-PN4056CD*	H				
45	M4	5X114,3	67					M12X1,50	O-PN4556CD* NEW	H				
50	M4	5X114,3	67					M12X1,50	O-PN5056CD*	H				
B 2500 Type UN	1996	2005						30	M4	6X139,7	108	M12X1,50	O-PFSM130	Y
								40	M4	6X139,7	108	M12X1,50	O-PNFSM140*	Y
								50	M4	6X139,7	108	M12X1,50	O-PNFSM150*	Y
								60	M4	6X139,7	108	M12X1,50	O-PNFSM160* NEW	Y

MERCEDES

MODELLO / MODEL	ANNO / YEAR DA / START	A / END	NOTA CHIAVE KEY NOTE	SPESSORE THICKNESS (mm)	TIPO TYPE	INTERASSE C TO C	Ø	FILETTO THREAD	CODICE CODE #	NOTE NOTES
SOLO ASSE ANTERIORE / ONLY FRONT AXLE										
190 (201)	1982	1993	1-17							
200-280E (123)-(123C)-(T)	1977	1986	1-17							
200-300 (115)	1967	1976	1-17	5	M1	5X112	66,5		0-P0516S	A-Y
230-280 (114)	1967	1976	1-17							
Classe A (W168)	1997	2003	1-17							
Classe C (W201)	Oct/1982	Aug/1993	1-17							
Classe C (W202)-(HQ)	Mar/1993	Mar/2001	1-17							
Classe C Inklus. Coupe (W203)-(W203K)-(W203CL)	May/2000	May/2007	1-17	12	M1	5X112	66,5		0-P12104S	D
CLK (208)	1997	2002	1-17							
CLK (209)	2002	2010	1-17							
Classe E (W123)	1976	1985	1-17							
Classe E (W124)	1985	1995	1-17							
Classe E (W210)	1995	2002	1-17	16	M1	5X112	66,5		0-P16104S	D
Classe S (116)	1972	1980	1-17							
Classe S (126)-(126C)	1980	1991	1-17							
SL (R107) MKI	1974	1985	1-17							
SL (R107) MKII	1985	1989	1-17							
SL (W129)	Mar/1989	Oct/2001	1-17							
SLK (R170)	Apr/1996	Mar/2004	1-17	20	M1	5X112	66,5		0-P20104S	D
SLK (R171)	Mar/2004	2010	1-17							
Vaneo (414)	2002	2005	1-17							

SOLO ASSE POSTERIORE / ONLY REAR AXLE

190 (201)	1982	1993	2-17	5	M1	5X112	66,5		0-P0516S	A-Y
200-280E (123)-(123C)-(T)	1977	1986	2-17							
200-300 (115)	1967	1976	2-17	12	M1	5X112	66,5		0-P1216S	Q
230-280 (114)	1967	1976	2-17							
Classe A (W168)	1997	2003	2-17	16	M1	5X112	66,5		0-P1616S	Q
Classe C (W201)	Oct/1982	Aug/1993	2-17							
Classe C (W202)-(HQ)	Mar/1993	Mar/2001	2-17	20	M1	5X112	66,5		0-P2016S	Q
Classe C Inklus. Coupe (W203)-(W203K)-(W203CL)	May/2000	May/2007	2-17							
CLK (208)	1997	2002	2-17	20	M4	5X112	66,5	M12X1,50	0-PN2016CD*	
CLK (209)	2002	2010	2-17							
Classe E (W123)	1976	1985	2-17	25	M5	5X112	66,5	M12X1,50	0-P2516CD	Q
Classe E (W124)	1985	1995	2-17							
Classe E (W210)	1995	2002	2-17	30	M5	5X112	66,5	M12X1,50	0-P3016CD	Q
Classe S (116)	1972	1980	2-17							
Classe S (126)-(126C)	1980	1991	2-17	35	M5	5X112	66,5	M12X1,50	0-PN3516CD*	
SL (R107) MKI	1974	1985	2-17							
SL (R107) MKII	1985	1989	2-17	40	M5	5X112	66,5	M12X1,50	0-PN4016CD*	
SL (W129)	Mar/1989	Oct/2001	2-17							
SLK (R170)	Apr/1996	Mar/2004	2-17	50	M5	5X112	66,5	M12X1,50	0-PN5016CD*	
SLK (R171)	Mar/2004	2010	2-17							
Vaneo (414)	2002	2005	2-17	60	M5	5X112	66,5	M12X1,50	0-PN6016CD*	

MERCEDES

MODELLO / MODEL	ANNO / YEAR DA / START	A / END	NOTA CHIAVE KEY NOTE	SPESSORE THICKNESS (mm)	TIPO TYPE	INTERASSE C TO C	Ø	FILETTO THREAD	CODICE CODE #	NOTE NOTES
SOLO ASSE ANTERIORE / ONLY FRONT AXLE										
AMG GT/GTC/GTS Type 197-C190	2014	>	17							
AMG GT 4 Türer Coupe Type X290	2018	>	17							
Classe A (W169)	2004	2012	17							
Classe A (W176)	2012	2018	17							
Classe A (W177)	2018	>	17							
Classe B (W245)	2005	2011	17	5	M1	5X112	66,5		O-P0516S	A-Y
Classe B (W246)	2011	>	17							
Classe B (W247)	2018	>	17							
Classe C (W204)	Apr/2007	2013	1-17							
Classe C (W205)	2014	>	17							
CL (215)	1999	2005	1-17							
CL (216)	Sept/2006	2013	1-17							
CLA (117)-(245G)	2013	>	1-17							
CLA (X117)-(245G)	2015	>	1-17							
CLA (X118)-(F2CLA)	2019	>	1-17							
Classe E (W211)	2002	Mar/2009	1-17	12	M1	5X112	66,5		O-P12104S	D
Classe E (W212)	Mar/2009	2016	1-17							
Classe E (W213)	2016	>	1-17							
Classe E All-Terrain (R1ES)-(S213)	2017	>	1-17							
Classe E Cabrio (A238)-(R1EC)	2016	>	1-17							
Classe E Coupé (207)	Mar/2009	2016	1-17							
Classe E Coupé (C238)	2016	>	1-17							
EQC (293 - 204X)	2019	>	17							
Classe GL (G164)	Sept/2006	2012	17							
Classe GL (166)	2012	2015	17							
Classe GLA (X156)	2014	>	17							
Classe GLA (H247)	2020	>	17	16	M1	5X112	66,5		O-P16104S	D
Classe GLB (X247)-(F2B)	2019	>	17							
Classe GLC Inklus. Coupe (X253)-(204X)	2015	>	17							
Classe GLE Inklus. Coupe (C292)-(166)	2015	2018	17							
Classe GLK (X204)	2008	2015	17							
Classe GLS (166)	2015	2018	17							
Classe M (163)	1997	2005	17							
Classe M (164)	2005	2011	17							
Classe M (166)	2011	2015	17							
R-Klasse (251)	2006	2017	17	20	M1	5X112	66,5		O-P20104S	D
Classe S (W140)	1991	1998	1-17							
Classe S (W220)	1998	2005	1-17							
Classe S (221)	2005	2013	1-17							
Classe S (222)	2013	>	1-17							
Classe S Cabrio (A217)-(221)	2014	>	1-17							
Classe S Coupe (A217)-(221)	2017	>	1-17							
Classe SL (230)	2001	2011	17							
Classe SL (231)	2012	>	17							
Classe SLC (R172)	2016	>	17							
Classe SLK (R172)	2011	2016	17							
SLS (197)	2009	2014	17	30	M4	5X112	66,5	M14X1,50	O-PN30114CD*	
Classe V I/Vito (638)	1996	2003	17							
Classe V II/Vito (639)	2003	2014	17							
Classe V III/Vito (639/2)- (639/4)-(W447)	2014	>	17							
Viano (639)	2003	2014	17							

*DIAMOND FINISH / Finitura diamantata • Available in one week / Disponibile in una settimana

MERCEDES

MODELLO / MODEL	ANNO / YEAR DA / START A / END		NOTA CHIAVE KEY NOTE	SPESSORE THICKNESS (mm)	TIPO TYPE	INTERASSE C TO C	Ø	FILETTO THREAD	CODICE CODE #	NOTE NOTES
SOLO ASSE POSTERIORE / ONLY REAR AXLE										
AMG GT/GTC/GTS Type 197-C190	2014	>	17	5	M1	5X112	66,5		0-P0516S	A-Y
AMG GT 4 Türer Coupe Type X290	2018	>	17							
Classe A (W169)	2004	2012	17							
Classe A (W176)	2012	2018	17	12	M1	5X112	66,5		0-P1216S	Q
Classe A (W177)	2018	>	17							
Classe B (W245)	2005	2011	17							
Classe B (W246)	2011	>	17							
Classe B (W247)	2018	>	17	16	M1	5X112	66,5		0-P1616S	Q
Classe C (W204)	Apr/2007	2013	2-17							
Classe C (W205)	2014	2021	17							
Classe C (R2CW - W206)	2021	>	17							
CL (215)	1999	2005	2-17	20	M1	5X112	66,5		0-P2016S	Q
CL (216)	Sept/2006	2013	2-17							
CLA (117) - (245G)	2013	2018	2-17							
CLA (X117) - (245G)	2015	2018	2-17							
Classe E (W211)	2002	Mar/2009	2-17	20	M5	5X112	66,5	M14X1,50	0-PN2024CD*	
Classe E (W212)	Mar/2009	2016	2-17							
Classe E (W213)	2016	>	2-17							
Classe E All-Terrain (R1ES)-(S213)	2017	>	2-17	25	M5	5X112	66,5	M14X1,50	0-P2524CD	Q
Classe E Cabrio (A238)- (R1EC)	2016	>	2-17							
Classe E Coupé (207)	Mar/2009	2016	2-17							
Classe E Coupé (C238)	2016	>	2-17	30	M5	5X112	66,5	M14X1,50	0-P3024CD	Q
EQC (293 - 204X)	2019	>	2-17							
Classe GL (G164)	Sept/2006	2012	2-17							
Classe GL (166)	2012	2015	2-17							
Classe GLA (X156)	2014	>	2-17	35	M5	5X112	66,5	M14X1,50	0-PN3524CD*	
Classe GLA (H247)	2020	>	2-17							
Classe GLB (X247) - (F2B)	2019	>	2-17							
Classe GLC Inclus. Coupe (X253)-(204X)	2015	>	2-17	40	M5	5X112	66,5	M14X1,50	0-PN4024CD*	
Classe GLE Inclus. Coupe (C292)-(166)	2015	2018	2-17							
Classe GLK (X204)	2008	2015	2-17							
Classe GLS (166)	2015	2018	2-17	45	M5	5X112	66,5	M14X1,50	0-PN4524CD*	
Classe M (163)	1997	2005	2-17							
Classe M (164)	2005	2011	2-17							
Classe M (166)	2011	2015	2-17							
R-Klasse (251)	2006	2017	2-17	50	M5	5X112	66,5	M14X1,50	0-PN5024CD*	
Classe S (W140)	1991	1998	2-17							
Classe S (W220)	1998	2005	2-17							
Classe S (221)	2005	2013	2-17							
Classe S (222)	2013	>	2-17	55	M5	5X112	66,5	M14X1,50	0-PN5524CD*	
Classe S Cabrio (A217)-(221)	2014	>	2-17							
Classe S Coupe (A217)-(221)	2017	>	2-17							
Classe SL (230)	2001	2011	2-17	60	M5	5X112	66,5	M14X1,50	0-PN6024CD*	
Classe SL (231)	2012	>	2-17							
Classe SLC (R172)	2016	>	2-17							
Classe SLK (R172)	2011	2016	2-17							
SLS (197)	2009	2014	17	70	M5	5X112	66,5	M14X1,50	0-PN7024CD*	
Classe V I / Vito (638)	1996	2003	17							
Classe V II / Vito (639)	2003	2014	17							
Classe V III / Vito (639/2)- (639/4)-(W447)	2014	>	17							
Viano (639)	2003	2014	17	80	M5	5X112	66,5	M14X1,50	0-PN8024CD*	

*DIAMOND FINISH / Finitura diamantata • Available in one week / Disponibile in una settimana

MERCEDES

MODELLO / MODEL	ANNO / YEAR DA / START A / END	NOTA CHIAVE KEY NOTE	SPESSORE THICKNESS (mm)	TIPO TYPE	INTERASSE C TO C	Ø	FILETTO THREAD	CODICE CODE #	NOTE NOTES	
G Type 460 [460.2-460.3-461.4] G Type 461 [461-461N-461NN] G Type G63 AMG G Type G63-W464	1979 1991 2012 2018	1991 2009 > >	13	M1	5X130	84		0-PN13132S*		
			20	M1	5X130	84		0-PN20132S*		
			30	M6	5X130	84	M14X1,50		0-PFSM430	H
			35	M6	5X130	84	M14X1,50		0-PFSM435	H
			40	M6	5X130	84	M14X1,50		0-PNFSM440*	H
			20	M5	5X130	84	M14X1,50		0-PNFSM520*	NEW H
			25	M5	5X130	84	M14X1,50		0-PNFSM525*	NEW H
			30	M5	5X130	84	M14X1,50		0-PNFSM530*	NEW H
Sprinter I Type 901 / 905	1995	2006	13	M1	5X130	84		0-PN13132S*	H	
			20	M1	5X130	84		0-PN20132S*		
			30	M6	5X130	84	M14X1,50		0-PFSM430	H
			35	M6	5X130	84	M14X1,50		0-PFSM435	H
			40	M6	5X130	84	M14X1,50		0-PNFSM440*	H
			20	M5	5X130	84	M14X1,50		0-PNFSM520*	NEW H
			25	M5	5X130	84	M14X1,50		0-PNFSM525*	NEW H
Sprinter II Type 906-AC35G Sprinter III Type 906-910	2006 2018	2018 >	25	M5	6X130	84	M14X1,50	0-PNFSM625*	NEW H	
			30	M5	6X130	84	M14X1,50		0-PNFSM630*	NEW H
X Type 1.gen (470)	2017	>	25	M4	6X114,3	66	M12X1,25	0-PNFSN325*	H - M	
			30	M4	6X114,3	66	M12X1,25	0-PFSN330	H	
			40	M4	6X114,3	66	M12X1,25		0-PNFSN340*	H

MINI by BMW

MODELLO / MODEL	ANNO / YEAR DA / START A / END	NOTA CHIAVE KEY NOTE	SPESSORE THICKNESS (mm)	TIPO TYPE	INTERASSE C TO C	Ø	FILETTO THREAD	CODICE CODE #	NOTE NOTES
Mini Type R50 / R52 / R53 Cooper Cooper S Works One One D	June/2001 Mar/2002 Nov/2003 June/2001 June/2003	Dec/2006 Dec/2006 Dec/2010 Dec/2006 Dec/2006	5	M1	4X100	56		0-P0539S	A-Y
			5	M2a	4X100	56	M12X1,50	0-P0539C	Y
			12	M1	4X100	56		0-P1239S	
			12	M2a	4X100	56	M12X1,50	0-P1239C	
			16	M1	4X100	56		0-P1639S	
			16	M2a	4X100	56	M12X1,50	0-P1639C	
			20	M1	4X100	56		0-P2039S	
			20	M2a	4X100	56	M12X1,50	0-P2039C	
			35	M5	4X100	56	M12X1,50	0-PN3539CD*	
MINI BY BMW Type R55- R56-R57-R58-R59 Cooper D Cooper S One Clubman Coupé Jonh Cooper Works	Oct/2006 Oct/2006 Sept/2006 Sept/2006 Oct/2007 Sept/2011 Mar/2008	Jan/2014 Jan/2014 Jan/2014 Jan/2014 Jan/2014 Jan/2014 Jan/2014	5	M1	4X100	56		0-P0539S	A-Y
			5	M2a	4X100	56	M14X1,25	0-P0564C	Y
			12	M1	4X100	56		0-P1239S	
			12	M2a	4X100	56	M14X1,25	0-P1264C	
			16	M1	4X100	56		0-P1639S	
			16	M2a	4X100	56	M14X1,25	0-P1664C	
			20	M1	4X100	56		0-P2039S	
			20	M2a	4X100	56	M14X1,25	0-P2064C	
Countryman Type R60 UKL/X Paceman Type R61	Sept/2010 Apr/2012	2016 2016	5	M1	5X120	72,5		0-P0507S	A-Y
			5	M2a	5X120	72,5	M14X1,25	0-P05128C	Y
			12	M1	5X120	72,5		0-P1207S	
			12	M2a	5X120	72,5	M14X1,25	0-P12128C	
			16	M1	5X120	72,5		0-P1607S	
			16	M2a	5X120	72,5	M14X1,25	0-P16128C	
			20	M1	5X120	72,5		0-P2007S	
			20	M2a	5X120	72,5	M14X1,25	0-P20128C	
			20	M2a	5X120	72,5	M14X1,25	0-PN20128CD*	
			25	M5	5X120	72,5	M14X1,25	0-P25127CD	
			30	M5	5X120	72,5	M14X1,25	0-P30127CD	
			35	M5	5X120	72,5	M14x1,25	0-PN35127CD* NEW	
Cooper Inkl. S Type F55- F56-F57 Cooper SE Type SE Clubman Type F54 Countryman Type F60 John Cooper Works Inkl Cabrio Type F56-F57 - ULK-L John Cooper Works Inkl Cabrio Type F56-F57- FMCA	2014 2019 2015 2017 2014 2016	> > > > 2016 >	5	M1	5X112	66,45		0-P0516S	A-Y
			5	M2a	5X112	66,45	M14X1,25	0-P0543C	Y
			12	M1	5X112	66,45		0-P1216S	
			12	M2a	5X112	66,45	M14X1,25	0-P1243C	
			16	M1	5X112	66,45		0-P1616S	
			16	M2a	5X112	66,45	M14X1,25	0-P1643C	
			20	M1	5X112	66,45		0-P2016S	
			20	M2a	5X112	66,45	M14X1,25	0-P2043C	
			20	M2a	5X112	66,45	M14X1,25	0-PN2043CD* NEW	
			25	M5	5X112	66,45	M14X1,25	0-P2543CD NEW	
30	M5	5X112	66,45	M14X1,25	0-P3043CD NEW				

*DIAMOND FINISH / Finitura diamantata • Available in one week / Disponibile in una settimana

MITSUBISHI

MODELLO / MODEL	ANNO / YEAR DA / START A / END	NOTA CHIAVE KEY NOTE	SPESSORE THICKNESS (mm)	TIPO TYPE	INTERASSE C TO C	Ø	FILETTO THREAD	CODICE CODE #	NOTE NOTES	
Carisma Type DAO Colt Type CJO / CAO	1999 1992	2004 2003	5	M1	4X100	56		0-P0539S	A-Y	
			12	M1	4X100	56		0-P1239S		
			12	M2b	4X100	56	M12X1,50		0-P12113C	L
			16	M1	4X100	56			0-P1639S	
			16	M2b	4X100	56	M12X1,50		0-P16113C	L
			20	M2b	4X100	56			0-P2039S	
			20	M2b	4X100	56	M12X1,50		0-P20113C	L
			20	M4	4X100	56	M12X1,50		0-P2013CD	M
			25	M4	4X100	56	M12X1,50		0-PN2513CD*	M
			30	M4	4X100	56	M12X1,50		0-PN3013CD*	M
			35	M4	4X100	56	M12X1,50		0-PN3513CD*	
			40	M4	4X100	56	M12X1,50		0-PN4013CD*	
50	M4	4X100	56	M12X1,50		0-PN5013CD*				
Carisma DAO Colt Z30 Colt CZC/Z3B Galant E10/E30/E39/E50 Lancer Z30/C10/C50/C60/C70 Space Runner N10 Space Star Type D60	June/1999 June/2004 May/2006 1987 2003 Oct/1991 2001	2004 2012 2009 1996 2007 Aug/1999 2005	16	M1	4X114,3	67		0-P1611S		
			16	M2b	4X114,3	67	M12X1,50		0-P1611C	L
			20	M1	4X114,3	67			0-P2011S	
			20	M2b	4X114,3	67	M12X1,50		0-P2011C	L
			20	M4	4X114,3	67	M12X1,50		0-P2011CD	M
			25	M4	4X114,3	67	M12X1,50		0-PN2511CD*	M
Asx Type GA W Eclipse I Type D20 Eclipse II Type D30 Eclipse III Type D50 Eclipse IV Type 4G Eclipse Cross Type GK0 Evo V-VI-VII-VIII Type CTO Evo IX Type CTO Evo X Type CZO Grandis Lancer Type CYO Outlander Type CUOW Outlander Type CWOW Outlander Type CWO GT 3000 Z10 Pajero Pinin Type H 60W	Feb/2010 1990 1995 2000 2005 2018 < 2005 Apr/2008 May/2004 2008 2003 2006 2013 June/1992 1999	> 1995 2000 2005 2012 > 2005 2007 > 2011 > 2006 2012 > Aug/1999 2004	5	M1	5X114,3	67		0-P0556S	A-Y	
			12	M1	5X114,3	67			0-PN1256S*	
			14	M1	5X114,3	67			0-PN1456S*	
			16	M1	5X114,3	67			0-P1656S	
			16	M2b	5X114,3	67	M12X1,50		0-P1656C	L
			16	M2b	5X114,3	67	M12X1,50		0-P1659C	R
			20	M1	5X114,3	67			0-P2056S	
			20	M2b	5X114,3	67	M12X1,50		0-P2056C	L
			20	M2b	5X114,3	67	M12X1,50		0-P2059C	R
			20	M4	5X114,3	67	M12X1,50		0-P2056CD	M-H
			25	M4	5X114,3	67	M12X1,50		0-P2556CD	M-H
			30	M4	5X114,3	67	M12X1,50		0-P3056CD	M-H
			35	M4	5X114,3	67	M12X1,50		0-PN3556CD*	M-H
			40	M4	5X114,3	67	M12X1,50		0-PN4056CD*	H
			45	M4	5X114,3	67	M12X1,50		0-PN4556CD* NEW	H
			50	M4	5X114,3	67	M12X1,50		0-PN5056CD*	H

MITSUBISHI (Off-road)

Pajero V6 Type L 040 Pajero Sport Type V20/K90 L 200 Type 60T L300 Country 4x4 Montero Sport V20 Type L 040 Space Gear 4WD	< < < May/1980 < May/1995	2000 2001 2004 Apr/1994 2001 May/2000	30	M4	6X139,7	108	M12X1,50	0-PFSM130	M-Y
			40	M4	6X139,7	108	M12X1,50	0-PNFSM140*	Y
			50	M4	6X139,7	108	M12X1,50	0-PNFSM150*	Y
			60	M4	6X139,7	108	M12X1,50	0-PNFSM160* NEW	Y
L 200 Type KAOT L 200 Type KJOT Pajero IV Type V80-V90 Pajero III Type V60 Montero V60	2006 2014 2007 2000 2000	2016 > 2015 Nov/2006 Nov/2006	30	M4	6X139,7	67	M12X1,50	0-PFSM330	H
			40	M5	6X139,7	67	M12X1,50	0-PNFSM340*	H
			50	M5	6X139,7	67	M12X1,50	0-PNFSM350*	H

*DIAMOND FINISH / Finitura diamantata • Available in one week / Disponibile in una settimana

NISSAN

MODELLO / MODEL	ANNO / YEAR DA / START A / END	NOTA CHIAVE KEY NOTE	SPESSORE THICKNESS (mm)	TIPO TYPE	INTERASSE C TO C	Ø	FILETTO THREAD	CODICE CODE #	NOTE NOTES
Micra III Type K12 Micra III CC Type K12 Micra IV Type K13 Micra V Type K14 Note Type E11	2003 Feb/2006 2010 2017 Mar/2006	Sept/2010 Sept/2010 2016 > Feb/2014	5	M1	4X100	60		0-P0519S	A-Y
			5	M2a	4X100	60	M12X1,50	0-P0519C	Y
			9	M1	4X100	60		0-PN0919S*	Y
			17	M1	4X100	60		0-P1719S	
			17	M2a	4X100	60	M12X1,50	0-P1719C	
			20	M1	4X100	60		0-P2019S	
			20	M2a	4X100	60	M12X1,50	0-P2019C	
			20	M5	4X100	60	M12X1,50	0-PN2019CD*	
			25	M5	4X100	60	M12X1,50	0-P2519CD	
			30	M5	4X100	60	M12X1,50	0-P3019CD	
			35	M5	4X100	60	M12X1,50	0-P3519CD	
			40	M5	4X100	60	M12X1,50	0-P4019CD	
			45	M5	4X100	60	M12X1,50	0-P4519CD	
50	M5	4X100	60	M12X1,50	0-P5019CD				
200 SX S13 Almera N16 Blue Bird U11,WU11,T*12,*72 Cube Z11 Cube Z12 Cherry N12 Evalia M20M Laurel JC32 Prairie M1 Prairie NM10/M11 Primeria P10 Primeria P1 Tilda C11 Urvan E24L	1889 2000 1983 2002 Mar/2010 1982 Oct/2011 1984 1980 1990 1990 1996 2008 1988	1993 2006 1986 2008 1987 > 1989 1989 1998 1997 2002 > 1997	5	M1	4X114,3	66		0-PN0523S*	Y
			16	M1	4X114,3	66		0-P1623S	
			16	M2b	4X114,3	66	M12X1,25	0-P1623C	E
			16	M2b	4X114,3	66	M12X1,25	0-P16116C	I
			20	M1	4X114,3	66		0-P2023S	
			20	M2b	4X114,3	66	M12X1,25	0-P2023C	E
			20	M2b	4X114,3	66	M12X1,25	0-P20116C	I
			20	M4	4X114,3	66	M12X1,25	0-PN2023CD*	
			30	M4	4X114,3	66	M12X1,25	0-PN3023CD*	
			35	M1	4X114,3	66	M12X1,25	0-PN3523CD*	
			40	M4	4X114,3	66	M12X1,25	0-PN4023CD*	
			45	M4	4X114,3	66	M12X1,25	0-PN4523CD* NEW	
			50	M4	4X114,3	66	M12X1,25	0-PN5023CD*	
Almera Tino Type V10 GT-R Type R35 Qashqai I Type J10 (NO TYPE J11) Maxima QX Type A33 Murano Type Z50 Murano Type Z51 Primeria P12 Pulsar Type C13 Serena Type C25 Silvia Type S14 Skyline Type R34 Skyline GT-R Type R34 200 Type S14 SX Juke Type F15 X Trail Type T30 X Trail Type T31 X Trail Type T32 300 ZX Type Z31 / Z32 350Z Type Z33 370Z Type Z34	2000 2008 Feb/2007 2000 Mar/2005 Jan/2009 2002 Oct/2014 1998 1994 1998 1998 Oct/1993 Sept/2010 June/2001 Sept/2007 Mar/2014 Jan/1984 Oct/2003 July/2009	2002 2014 Dec/2013 2006 Dec/2008 > 2006 > 2001 > 2002 2002 Dec/1999 2018 Sept/2007 Oct/2013 > Dec/1997 June/2009 >	5	M1	5X114,3	66		0-P0553S	A-Y
			7	M1	5X114,3	66		0-PN0753S*	Y
			16	M1	5X114,3	66		0-P1653S	
			16	M2b	5X114,3	66	M12X1,25	0-P1653C	I
			16	M2b	5X114,3	66	M12X1,25	0-P16117C	E
			20	M1	5X114,3	66		0-P2053S	
			20	M2b	5X114,3	66	M12X1,25	0-P2053C	I
			20	M2b	5X114,3	66	M12X1,25	0-P20117C	E
			20	M4	5X114,3	66	M12X1,25	0-P2053CD	M
			30	M4	5X114,3	66	M12X1,25	0-P3053CD	M
			35	M4	5X114,3	66	M12X1,25	0-PN3553CD*	
			40	M4	5X114,3	66	M12X1,25	0-PN4053CD*	
			50	M4	5X114,3	66	M12X1,25	0-PN5053CD*	
			60	M4	5X114,3	66	M12X1,25	0-PN6053CD*	

NISSAN

MODELLO / MODEL	ANNO / YEAR DA / START	YEAR A / END	NOTA CHIAVE KEY NOTE	SPESSORE THICKNESS (mm)	TIPO TYPE	INTERASSE C TO C	Ø	FILETTO THREAD	CODICE CODE #	NOTE NOTES	
Qashqai II Type J11 (NO TYPE J10) Juke Type F16 (NO TYPE F15)	Jan/2014	>		5	M1	5X114,3	66	M12X1,50	O-P0553S	A-Y	
				17	M1	5X114,3	66	M12X1,50	O-P1775S		
				17	M2a	5X114,3	66	M12X1,50	O-P1776C		
				20	M1	5X114,3	66	M12X1,50	O-P2075S		
				20	M2a	5X114,3	66	M12X1,50	O-P2076C		
				20	M5	5X114,3	66	M12X1,50	O-PN2076CD*		
	2019	>			22	M2a	5X114,3	66	M12X1,50	O-PN2276C*	
					25	M5	5X114,3	66	M12X1,50	O-PN2576CD*	
					30	M5	5X114,3	66	M12X1,50	O-PN3076CD*	
					35	M5	5X114,3	66	M12X1,50	O-PN3576CD*	
					40	M5	5X114,3	66	M12X1,50	O-PN4076CD*	
					45	M5	5X114,3	66	M12X1,50	O-PN4576CD*	
100NX Type B13 Almera Type N15 Micra Type K10 Micra Type K11 Sunny Type B11-11A-12A Sunny Type Y1-10-10L-N13 Sunny Type N14	1990	1995		20	M1	4x100	59	M12x1,25	O-PN2032S*		
	1995	2000		30	M4	4x100	59	M12x1,25	O-PN3032CD*	NEW	
	1982	1993									
	1993	2003									
	1981	1985									
1986	2006		40	M4	4x100	59	M12x1,25	O-PN4032CD*			
1990	1995										
Interstar Type F3-FDN-J3 NV400 Type I	2002	2010		30	M5	5x130	89	M14X1,5	O-PN30145CD*	H	
	2010	>		60	M5	5x130	89	M14X1,5	O-PN60145CD*	H	

NISSAN (Off-road)

Terrano I Type WD21 Terrano II Type R20 Navara Type D22 Pathfinder Type R50 Patrol K260 / K160 Pick up MD 21/D22	1986	1993		30	M4	6X139,7	108	M12X1,25	O-PFSN130	M-Y
	1993	2006								
	<	2005								
Navara Type D40 Navara Type D401 Navara Type NP300 Pathfinder Type R51	<	2005		35	M4	6X139,7	108	M12X1,25	O-PNFSN135*	Y
	Nov/1979	Nov/1995								
	Jan/1997	2007								
	2005	2012								
Navara Type D40 Navara Type D401 Navara Type NP300 Pathfinder Type R51	2005	2012		40	M4	6X139,7	108	M12X1,25	O-PNFSN140*	Y
	2012	2016								
	2016	>								
	2005	2007								
Patrol I GR Type Y60A Patrol II GR Type Y61	Aug/1987 June/1997	June/1997 2009		25	M4	6X114,3	66	M12X1,25	O-PNFSN325*	M-H
				30	M4	6X114,3	66	M12X1,25	O-PFSN330	M-H
				40	M4	6X114,3	66	M12X1,25	O-PNFSN340*	H
Patrol I GR Type Y60A Patrol II GR Type Y61	Aug/1987 June/1997	June/1997 2009		50	M4	6X114,3	66	M12X1,25	O-PNFSN350*	H
				30	M4	6X139,7	112	M12X1,25	O-PFSN230	M-Y
				40	M4	6X139,7	112	M12X1,25	O-PNFSN240*	Y
				50	M4	6X139,7	112	M12X1,25	O-PNFSN250*	Y

OPEL

MODELLO / MODEL	ANNO / YEAR DA / START A / END	NOTA CHIAVE KEY NOTE	SPESSORE THICKNESS (mm)	TIPO TYPE	INTERASSE C TO C	Ø	FILETTO THREAD	CODICE CODE #	NOTE NOTES	
Agila Type H-B	2008	2014		5	M1	4X100	54		0-PN0514S*	
				16	M1	4X100	54		0-P1614S	
				16	M2a	4X100	54	M12X1,50	0-P1665C	C
				16	M2a	4X100	54	M12X1,50	0-P16112C	U
				20	M1	4X100	54		0-P2014S	
				20	M2a	4X100	54	M12X1,50	0-P2065C	C
Adam Type S-D Astra Type A / H Corsa A Type A-CC Corsa B Type S93 Corsa C Type C Corsa D Type S-D Corsa E Type S-D Meriva Type X01 Tigra Type A Tigra Type XC / Twin Top Vectra Type A Vectra Type B Viva Type D-A Calibra Type A Kadett Type E Karl Type D-A	Jan/2013 2004 1982 1993 2000 Oct/2006 2014 May/2003 July/1994 2004 1988 1995 2015 June/1990 Aug/1979 2015	> Oct/2009 1993 1999 2005 2014 > May/2010 Dec/2000 2009 1994 2001 > July/1997 Aug/1994 >	6 6 6 6 6 6 6 6 6 6 6 6 6 6 6 6 6	5	M1	4X100	56,5		0-P0517S	A-Y
				5	M2a	4X100	56,5	M12X1,50	0-P0517C	B-Y
				5	M2a	4X100	56,5	M12X1,50	0-P05106C	C-Y
				12	M1	4X100	56,5		0-PN1217S*	D
				12	M2a	4X100	56,5	M12X1,50	0-PN1217C*	D
				17	M1	4X100	56,5		0-P1717S	
				17	M2a	4X100	56,5	M12X1,50	0-P1717C	B
				17	M2a	4X100	56,5	M12X1,50	0-P17106C	C
				20	M1	4X100	56,5		0-P2017S	
				20	M2a	4X100	56,5	M12X1,50	0-P2017C	B
				20	M2a	4X100	56,5	M12X1,50	0-P20106C	C
				25	M5	4X100	56,5	M12X1,50	0-P2517CD	
				25	M4	4X100	56,5	M12X1,50	0-PN2517CCP*	
				30	M5	4X100	56,5	M12X1,50	0-P3017CD	
				35	M5	4X100	56,5	M12X1,50	0-P3517CD	
				40	M5	4X100	56,5	M12X1,50	0-P4017CD	
				45	M5	4X100	56,5	M12X1,50	0-PN4517CD*	
				50	M5	4X100	56,5	M12X1,50	0-PN5017CD*	
Combo D Type Combo D-VAN	2011	>		5	M1	5X98	58		0-P0504S	A-Y
				5	M2a	5X98	58	12X1,25	0-P0504C7	B-Y
				5	M2a	5X98	58	12X1,25	0-P05108C	C-Y
				12	M1	5X98	58		0-P1204S	
				12	M2a	5X98	58	12X1,25	0-P1204C7	B
				12	M2a	5X98	58	12X1,25	0-P12108C	C
				16	M1	5X98	58		0-P1604S	
				16	M2a	5X98	58	12X1,25	0-P1604C7	B
				16	M2a	5X98	58	12X1,25	0-P16108C	C
				20	M1	5X98	58		0-P2004S	
				20	M2a	5X98	58	12X1,25	0-P2004C7	B
				20	M2a	5X98	58	12X1,25	0-P20108C	C
				25	M5	5X98	58	12X1,25	0-P2504CD	
30	M5	5X98	58	12X1,25	0-P3004CD					

OPEL

MODELLO / MODEL	ANNO / YEAR DA / START A / END	NOTA CHIAVE KEY NOTE	SPESSORE THICKNESS (mm)	TIPO TYPE	INTERASSE C TO C	Ø	FILETTO THREAD	CODICE CODE #	NOTE NOTES	
Corsa F Type U Crossland X Type P7 MO- NOCAB C	2019 2017	> >		5	M1	4X108	65		0-P0518S	A-Y
				5	M2a	4X108	65	M12X1,25	0-P0518C7	C-Y
				5	M3b	4X108	65	M12X1,25	0-P0518CP7	S-Y
				12	M1	4X108	65		0-P1218S	
				12	M2a	4X108	65	M12X1,25	0-P1218C7	C
				12	M3b	4X108	65	M12X1,25	0-P1218CP7	S
				16	M1	4X108	65		0-P1618S	
				16	M2a	4X108	65	M12X1,25	0-P1618C7	C
				16	M3b	4X108	65	M12X1,25	0-P1618CP7	S
				20	M1	4X108	65		0-P2018S	
				20	M2a	4X108	65	M12X1,25	0-P2018C7	C
				20	M3b	4X108	65	M12X1,25	0-P2018CP7	S
				25	M5	4X108	65	M12X1,25	0-P2518CD	
				30	M5	4X108	65	M12X1,25	0-P3018CD	
				35	M5	4X108	65	M12X1,25	0-P3518CD	
				40	M5	4X108	65	M12X1,25	0-P4018CD	
	45	M5	4X108	65	M12X1,25	0-P4518CD				
	50	M5	4X108	65	M12X1,25	0-P5018CD				
Combo E Type E Grandland X Type Z Vivaro Type C Zafira Life Type K0	2018 2017 2019 2019	> > > >		5	M1	5X108	65		0-P0531S	A-Y
				5	M2a	5X108	65	M12X1,25	0-P0558C7	C-Y
				5	M3b	5X108	65	M12X1,25	0-P0558CP7	S-Y
				12	M1	5X108	65		0-P1231S	
				12	M2a	5X108	65	M12X1,25	0-P1258C7	C
				12	M3b	5X108	65	M12X1,25	0-P1258CP7	S
				16	M1	5X108	65		0-P1631S	
				16	M2a	5X108	65	M12X1,25	0-P1658C7	C
				16	M3b	5X108	65	M12X1,25	0-P1658CP7	S
				20	M1	5X108	65		0-P2031S	
				20	M2a	5X108	65	M12X1,25	0-P2058C7	C
				20	M3b	5X108	65	M12X1,25	0-P2058CP7	S
				25	M5	5X108	65	M12X1,25	0-PN2558CD*	
				30	M5	5X108	65	M12X1,25	0-PN3058CD*	
	35	M5	5X108	65	M12X1,25	0-PN3558CD*				
	50	M5	5X108	65	M12X1,25	0-PN5058CD*				
Adam Type S-D Astra Type A/HC Astra GTC Astra OPC / Twin Top Astra Type T98 Calibra Type A Corsa C 1.7 CDTI Corsa Type S-D Meriva Type X01 1.7 CDTI Meriva Type S-D Signum Type Z-CS Speedster Omega Type B Vectra Type C Zafira A Type T98/MONOCAR Zafira B Type A-H/MONO- CAR/OPC	2014 2004 2005 2006 1998 June/1990 2000 Oct/2006 2003 2014 2003 2014 2003 Sept/2000 1993 2002 1999 2005	> Oct/2009 Oct/2009 Oct/2009 2003 July/1997 Sept/2006 2014 2010 > 2008 2005 2003 2008 2005 2014	7 7 7 7 7 7 7 7 7 7 7 7 7 7	5	M1	5X110	65		0-P0540S	A-Y
				5	M2a	5X110	65	M12X1,50	0-P0540C	Y
				17	M1	5X110	65		0-P1740S	
				17	M2a	5X110	65	M12X1,50	0-P1740C	
				20	M1	5X110	65		0-P2040S	
				20	M2a	5X110	65	M12X1,50	0-P2040C	
				30	M5	5X110	65	M12X1,50	0-PN3040CD*	
				35	M5	5X110	65	M12X1,50	0-PN3540CD*	
				40	M5	5X110	65	M12X1,50	0-PN4040CD*	
				50	M5	5X110	65	M12X1,50	0-PN5040CD*	

*DIAMOND FINISH / Finitura diamantata • Available in one week / Disponibile in una settimana

OPEL

MODELLO / MODEL	ANNO / YEAR DA / START	YEAR A / END	NOTA CHIAVE KEY NOTE	SPESSORE THICKNESS (mm)	TIPO TYPE	INTERASSE C TO C	Ø	FILETTO THREAD	CODICE CODE #	NOTE NOTES
Astra K Type B-K	2015	>		20	M4	5X105	56,5	M12X1,50	0-P2095CD	M
Astra J 1.3 Diesel Type P-J (105 X 5)	Nov/2009	2015		25	M4	5X105	56,5	M12X1,50	0-P2595CD	M
Astra J 1.4 Benzina/gasoline Type P-J (105 X 5)	Nov/2009	2015		30	M4	5X105	56,5	M12X1,50	0-P3095CD	M
Astra J 1.6 Benzina/gasoline (NO TURBO) Type P-J (105 X 5)	Nov/2009	2015								
Mokka Type J-A (105 X 5)	Mar/2012	>								
Ampera Type D1J01 (115 X 5)	Jan/2012	2016		20	M4	5X115	70	M12X1,50	0-P2096CD	M
Astra GTC Type J (115 X 5)	2011	2015		25	M4	5X115	70	M12X1,50	0-P2596CD	M
Astra J 1.7 Diesel Type P-J (115 X 5)	Nov/2009	2015		30	M4	5X115	70	M12X1,50	0-P3096CD	M
Astra J 2.0 Diesel Type P-J (115 X 5)	Nov/2009	2015		35	M4	5X115	70	M12X1,50	0-PN3596CD*	
Astra J 1.6 Turbo Benzina/gasoline Type P-J (115 X 5)	Nov/2009	2015		40	M4	5X115	70	M12X1,50	0-PN4096CD*	
Cascada Type P-J/SW (115 X 5)	Jan/2013	2018								
Insignia Type Z-B	2017	>								
Zafira C Type P-J/SW (115 X 5)	Nov/2011	2016								
Insignia Type OG-A	2008	2016		20	M4	5x120	67	M14x1,5	0-PN2089CD*	M
Insignia Country Tourer Type OG-A	2014	2016		25	M4	5x120	67	M14x1,5	0-PN2589CD*	M
Ascona Type A	1970	1975		30	M4	4x100	56,5	M12,1,5	0-PN3036CD*	
Ascona Type B	1975	1981								
GT Type 1100/1900	1968	1973								
Kadett B	1965	1973								
Kadett C	1973	1979								
Manta Type A	1970	1975		50	M4	4x100	56,5	M12x1,5	0-PN5036CD*	
Manta Type B/B-CC	1975	1988								
Vivaro Type F7-X83	2001	2014		5	M1	5x118	71		0-PN05103S*	
				25	M5	5x118	71	M14X1,5	0-PN25103CD*	H
				30	M5	5x118	71	M14x1,5	0-PN30103CD*	H
Vivaro Type B X83/F7	2014	2019		5	M1	5X114,3	66		0-P0553S	
				17	M1	5X114,3	66		0-P1775S	
				17	M2a	5X114,3	66	M14X1,50	0-P1775C	
				20	M1	5X114,3	66		0-P2075S	
				20	M2a	5X114,3	66	M14X1,50	0-P2075C	
				20	M5	5X114,3	66	M14X1,50	0-PN2075CD*	
				22	M2a	5X114,3	66	M14X1,50	0-PN2275C*	
				25	M5	5X114,3	66	M14X1,50	0-PN2575CD*	
				30	M5	5X114,3	66	M14X1,50	0-PN3075CD*	
				40	M5	5X114,3	66	M14X1,50	0-PN4075CD*	
				50	M5	5X114,3	66	M14X1,50	0-PN5075CD*	
Movano Type F9-H9-J9-N9-U9	1998	>		30	M5	5x130	89	M14X1,5	0-PN30145CD*	H
				60	M5	5x130	89	M14X1,5	0-PN60145CD*	H

OPEL Off-road

Antara Type L-A Sintra Type GM200 / GME	Dec/2006 Nov/1996	2015 Apr/1999		20	M4	5X115	70	M12X1,50	0-P2096CD	M-H
				25	M4	5X115	70	M12X1,50	0-P2596CD	M-H
				30	M4	5X115	70	M12X1,50	0-P3096CD	M-H
				35	M4	5X115	70	M12X1,50	0-PN3596CD*	H
				40	M4	5X115	70	M12X1,50	0-PN4096CD*	H
Frontera Type A/B / Sport Type R/S Campo Monterey	Mar/1992	Oct/1998		30	M4	6X139,7	108	M12X1,50	0-PFSM130	M-Y
				40	M4	6X139,7	108	M12X1,50	0-PNFSM140*	Y
				50	M4	6X139,7	108	M12X1,50	0-PNFSM150*	Y
				60	M4	6X139,7	108	M12X1,50	0-PNFSM160* NEW	Y

*DIAMOND FINISH / Finitura diamantata • Available in one week / Disponibile in una settimana

PEUGEOT

MODELLO / MODEL	ANNO / YEAR DA / START A / END	NOTA CHIAVE KEY NOTE	SPESSORE THICKNESS (mm)	TIPO TYPE	INTERASSE C TO C	Ø	FILETTO THREAD	CODICE CODE #	NOTE NOTES		
104 - 106 - tutti i modelli/all models/tous models		5	16	M1	3X98	55		O-P1603S			
			16	M2a	3X98	55	M12X1,25	O-P1603C			
			20	M1	3X98	55		O-P2003S			
			20	M2a	3X98	55	M12X1,25	O-P2003C			
			30	M5	3X98	55	M12X1,25	O-PN3003CD*			
			35	M5	3X98	55	M12X1,25	O-PN3503CD*			
			40	M5	3X98	55	M12X1,25	O-PN4003CD*			
106 Type 1A / 1C 205 Type 741A/C 206 Type 2 305 Type 581M 306 Type 7B/N3/N5/Cabriolet 309 Type 10C/10A 405 Type 15B 406 Type 8B Partner Type G	1991 Feb/1983 1998 Oct/1982 May/1993 Oct/1985 Jan/1987 Aug/1996 1992	2003 Sept/1998 July/2003 July/1990 June/2001 Dec/1993 Oct/1996 Oct/2003 July/2003	8	5	M1	4X108	65	M12X1,25	O-P0518S	A-Y	
			8	5	M2a	4X108	65	M12X1,25	O-P0518C	C-Y	
			8	12	M1	4X108	65		O-P1218S		
			8	12	M2a	4X108	65	M12X1,25	O-P1218C		C
			8	16	M1	4X108	65		O-P1618S		
			8	16	M2a	4X108	65	M12X1,25	O-P1618C		C
			8	20	M1	4X108	65		O-P2018S		
			8	20	M2s	4X108	65	M12X1,25	O-PN2018AC*	NEW	
			8	20	M2a	4X108	65	M12X1,25	O-P2018C		C
			8	20	M5	4X108	65	M12X1,25	O-PN2018CD*		Z2
			8	25	M1	4X108	65		O-PN2518S		Z2
			8	25	M5	4X108	65	M12X1,25	O-P2518CD		Z2
			8	30	M6	4X108	65	M12X1,25	O-PN3018CDP*		Z2
			8	30	M5	4X108	65	M12X1,25	O-P3018CD		Z2
			8	35	M5	4X108	65	M12X1,25	O-P3518CD		Z2
			8	40	M5	4X108	65	M12X1,25	O-P4018CD		Z2
			8	45	M5	4X108	65	M12X1,25	O-P4518CD		Z2
			8	50	M5	4X108	65	M12X1,25	O-P5018CD		Z2
			8	60	M5	4X108	65	M12X1,25	O-PN6018CD*		Z2
			8	70	M5	4X108	65	M12X1,25	O-PN7018CD*		Z2
106 Type 1 206 / CC Type 206 Plus Type 2 207 Type W 207 CC Type WD 208 I Type C 208 II Type UB-UP-UW-UJ e 208 Type UB-UP-UW-UJ 307 / CC Type 3 308 I Type 4 [*key note 6] 2008 I Type C 2008 II Type U e 2008 Type U 3008 Type QU 5008 1007 Type K Partner Type G Partner Type 7 Tepee/Ranch	Aug/2003 Aug/2001 Mar/2009 2006 Feb/2007 2012 2019 2020 Aug/2003 Nov/2007 2012 2019 2019 May/2009 Oct/2009 2004 Aug/2003 2008	2005 > > 2015 2015 2018 > > 2008 Aug/2013 2018 > > 2015 2018 2009 2009 Apr/2008 >	9	5	M1	4X108	65		O-P0518S	A-Y	
			9	5	M2a	4X108	65	M12X1,25	O-P0518C7		C-Y
			9	5	M3b	4X108	65	M12X1,25	O-P0518CP7		S-Y
			9	12	M1	4X108	65		O-P1218S		
			9	12	M2a	4X108	65	M12X1,25	O-P1218C7		C
			9	12	M3b	4X108	65	M12X1,25	O-P1218CP7		S
			9	16	M1	4X108	65		O-P1618S		
			9	16	M2a	4X108	65	M12X1,25	O-P1618C7		C
			9	16	M3b	4X108	65	M12X1,25	O-P1618CP7		S
			9	20	M1	4X108	65		O-P2018S		
			9	20	M2s	4X108	65	M12X1,25	O-PN2018AC*	NEW	
			9	20	M2a	4X108	65	M12X1,25	O-P2018C7		C
			9	20	M3b	4X108	65	M12X1,25	O-P2018CP7		S
			9	25	M5	4X108	65	M12X1,25	O-P2518CD		
			9	30	M5	4X108	65	M12X1,25	O-P3018CD		
			9	35	M5	4X108	65	M12X1,25	O-P3518CD		
			9	40	M5	4X108	65	M12X1,25	O-P4018CD		
			9	45	M5	4X108	65	M12X1,25	O-P4518CD		
			9	50	M5	4X108	65	M12X1,25	O-P5018CD		

PEUGEOT

MODELLO / MODEL	ANNO / YEAR DA / START A / END	NOTA CHIAVE KEY NOTE	SPESSORE THICKNESS (mm)	TIPO TYPE	INTERASSE C TO C	Ø	FILETTO THREAD	CODICE CODE #	NOTE NOTES		
Bipper Type A	2008	>		5	M1	4X98	58		0-P0510S	A-Y	
				5	M2a	4X98	58	M12X1,25	0-P0510C7	B-Y	
				5	M2a	4X98	58	M12X1,25	0-P05105C	C-Y	
				12	M1	4X98	58		0-P1210S		
				12	M2a	4X98	58	M12X1,25	0-P1210C7	B	
				12	M2a	4X98	58	M12X1,25	0-P12105C	C	
				16	M1	4X98	58		0-P1610S		
				16	M2a	4X98	58	M12X1,25	0-P1610C7	B	
				16	M2a	4X98	58	M12X1,25	0-P16105C	C	
				20	M1	4X98	58		0-P2010S		
				20	M2a	4X98	58	M12X1,25	0-P2010C7	B	
				20	M2a	4X98	58	M12X1,25	0-P20105C	C	
				25	M5	4X98	58	M12X1,25	0-P2510CD		
				30	M5	4X98	58	M12X1,25	0-P3010CD		
				35	M5	4X98	58	M12X1,25	0-P3510CD		
	40	M5	4X98	58	M12X1,25	0-P4010CD					
	45	M5	4X98	58	M12X1,25	0-P4510CD					
	50	M5	4X98	58	M12X1,25	0-P5010CD					
107 Type P 108 Type P	2005 2014	> >		5	M1	4X100	54		0-PN0514S*		
				16	M1	4X100	54		0-P1614S		
				16	M2a	4X100	54	M12X1,50	0-P1665C	C	
				16	M2a	4X100	54	M12X1,50	0-P16112C	U	
				20	M1	4X100	54		0-P2014S		
				20	M2a	4X100	54	M12X1,50	0-P2065C	C	
				20	M2a	4X100	54	M12X1,50	0-P20112C	U	
	25	M5	4X100	54	M12X1,50	0-PN2565CD*					
308 II Type L 3008 II Type M 407 Type 6D / 6E 508 II Type F 508 Type 8 508 RXH Type 8 RXH 508 SW Type 8 SW 605 Type 6B 607 Type 9 Expert II Type X Expert III Type V RCZ Type 4J 5008	Sept/2013 2016 May/2004 2018 2010 2011 2011 June/1989 1999 2007 2016 2010 2019	> > 2011 > 2018 2018 2018 Sept/1999 July/2003 > > 2015 >	7-9 9 9 9 9 9 9 9 9 9 9 9 9 9 9 9		5	M1	5X108	65		0-P0531S	A-Y
					5	M2a	5X108	65	M12X1,25	0-P0558C7	C-Y
					5	M3b	5X108	65	M12X1,25	0-P0558CP7	S-Y
					12	M1	5X108	65		0-P1231S	
					12	M2a	5X108	65	M12X1,25	0-P1258C7	C
					12	M3b	5X108	65	M12X1,25	0-P1258CP7	S
					16	M1	5X108	65		0-P1631S	
					16	M2a	5X108	65	M12X1,25	0-P1658C7	C
					16	M3b	5X108	65	M12X1,25	0-P1658CP7	S
					20	M1	5X108	65		0-P2031S	
					20	M2a	5X108	65	M12X1,25	0-P2058C7	C
					20	M3b	5X108	65	M12X1,25	0-P2058CP7	S
					25	M5	5X108	65	M12X1,25	0-PN2558CD*	
					30	M5	5X108	65	M12X1,25	0-PN3058CD*	
					35	M5	5X108	65	M12X1,25	0-PN3558CD*	
					40	M5	5X108	65	M12X1,25	0-PN4058CD*	NEW
					50	M5	5X108	65	M12X1,25	0-PN5058CD*	

PEUGEOT

MODELLO / MODEL	ANNO / YEAR DA / START A / END	NOTA CHIAVE KEY NOTE	SPESSORE THICKNESS (mm)	TIPO TYPE	INTERASSE C TO C	Ø	FILETTO THREAD	CODICE CODE #	NOTE NOTES
806 Type A/221 807 Type E Expert I Type B 224	June/1994 June/2002 1995	Aug/2002 Sept/2013 2007	5	M1	5X98	58		O-P0504S	A-Y
			5	M2a	5X98	58	M14,50	O-P0549C	Y
			12	M1	5X98	58		O-P1204S	
			12	M2a	5X98	58	M14,50	O-P1249C	
			16	M1	5X98	58		O-P1604S	
			16	M2a	5X98	58	M14,50	O-P1649C	
			20	M1	5X98	58		O-P2004S	
4007 Type GP 4008 Type B	Jan/2007 2012	2012 2015	16	M1	5X114,3	67		O-P1656S	
			16	M2b	5X114,3	67	M12X1,50	O-P1656C	L
			16	M2b	5X114,3	67	M12X1,50	O-P1659C	R
			20	M1	5X114,3	67		O-P2056S	
			20	M2b	5X114,3	67	M12X1,50	O-P2056C	L
			20	M2b	5X114,3	67	M12X1,50	O-P2059C	R
			20	M4	5X114,3	67	M12X1,50	O-P2056CD	M-H
			25	M4	5X114,3	67	M12X1,50	O-P2556CD	M-H
			30	M4	5X114,3	67	M12X1,50	O-P3056CD	M-H
			35	M4	5X114,3	67	M12X1,50	O-PN3556CD*	M-H
			40	M4	5X114,3	67	M12X1,50	O-PN4056CD*	H
			45	M4	5X114,3	67	M12X1,50	O-PN4556CD* NEW	H
			50	M4	5X114,3	67	M12X1,50	O-PN5056CD*	H

PORSCHE

MODELLO / MODEL	ANNO / YEAR DA / START A / END	NOTA CHIAVE KEY NOTE	SPESSORE THICKNESS (mm)	TIPO TYPE	INTERASSE C TO C	Ø	FILETTO THREAD	CODICE CODE #	NOTE NOTES
Boxter/Boxter S Type 986 Boxter/Boxter S Type 987 Boxter/Boxter S Type 981 718 Boxter Type 982 718 Cayman Type 982 Cayman GT4 Type 981 Cayman S Type 987 Cayman S Type 981 Carrera Type GT Carrera S/4S Type 991 911 Type 996 911 Type 997 911 Type 991 Taycan Type Y1A	Sept/1996 2004 2012 2012 2016 2016 2016 2015 Nov/2005 2013 July/2003 2012 Sept/1997 July/2004 Jan/2012 2019	2004 2012 2016 > > > > 2013 2016 > > Aug/2005 2012 > >	5	M1	5X130	71,5		O-P0537S	H
			5	M1	5X130	71,5		O-PN0537SC*	H-Y
			5	M3a	5X130	71,5	M14X1,50	O-P05125C	N-H
			8	M1	5X130	71,5		O-PN0837S* NEW	H
			10	M1	5X130	71,5		O-PN1037S* NEW	H
			12	M1	5X130	71,5		O-P1237S	
			12	M3a	5X130	71,5	M14X1,50	O-P12125C	N
			16	M1	5X130	71,5		O-P1637S	
			16	M3a	5X130	71,5	M14X1,50	O-P16125C	N
			20	M1	5X130	71,5		O-P2037S	
			20	M3a	5X130	71,5	M14X1,50	O-P20125C	N
			20	M5	5X130	71,5	M14X1,50	O-PN2092CD*	H
			25	M5	5X130	71,5	M14X1,50	O-P2592CD	H
			30	M5	5X130	71,5	M14X1,50	O-P3092CD	H
			35	M5	5X130	71,5	M14X1,50	O-PN3592CD*	H
			40	M5	5X130	71,5	M14X1,50	O-PN4092CD*	H
			50	M5	5X130	71,5	M14X1,50	O-PN5092CD*	H
			60	M5	5X130	71,5	M14X1,50	O-PN6092CD*	H
			70	M5	5X130	71,5	M14X1,50	O-PN7092CD*	H
			80	M5	5X130	71,5	M14X1,50	O-PN8092CD*	H

*DIAMOND FINISH / Finitura diamantata • Available in one week / Disponibile in una settimana

PORSCHE

MODELLO / MODEL	ANNO / YEAR DA / START	YEAR A / END	NOTA CHIAVE KEY NOTE	SPESORE THICKNESS (mm)	TIPO TYPE	INTERASSE C TO C	Ø	FILETTO THREAD	CODICE CODE #	NOTE NOTES
Cayenne 955/957 Type 9PA Cayenne 958 Type 92A/92AN/92AH/92AHN Panamera GTS Type 970/970N Panamera S/4/4S Type 970/970N Panamera S/4/4S Type 971	Sept/2002 2010	2010 2016	14 14	5	M1	5X130	71,5		0-P0537S	H
				5	M3a	5X130	71,5	M14X1,50	0-P0537CS	N-H
	2009	2016	14	8	M1	5X130	71,5		0-PN0837S* NEW	H
				10	M1	5X130	71,5		0-PN1037S* NEW	H
	2009	2016	14	12	M1	5X130	71,5		0-P1237S	
				12	M3a	5X130	71,5	M14X1,50	0-P1237CS	N
	2016	>	14	16	M1	5X130	71,5		0-P1637S	
				16	M3a	5X130	71,5	M14X1,50	0-P1637CS	N
	2009	2016	14	20	M1	5X130	71,5		0-P2037S	
				20	M3a	5X130	71,5	M14X1,50	0-P2037CS	N
	2009	2016	14	20	M5	5X130	71,5	M14X1,50	0-PN2092CD*	H
				25	M5	5X130	71,5	M14X1,50	0-P2592CD	H
	2016	>	14	30	M5	5X130	71,5	M14X1,50	0-P3092CD	H
				35	M5	5X130	71,5	M14X1,50	0-PN3592CD*	H
	2016	>	14	40	M5	5X130	71,5	M14X1,50	0-PN4092CD*	H
				50	M5	5X130	71,5	M14X1,50	0-PN5092CD*	H
2016	>	14	60	M5	5X130	71,5	M14X1,50	0-PN6092CD*	H	
			70	M5	5X130	71,5	M14X1,50	0-PN7092CD*	H	
2016	>	14	80	M5	5X130	71,5	M14X1,50	0-PN8092CD*	H	
911 Type 993 911 Carrera/Targa Type 911 911 Carrera/Cabrio/Targa 914 Type 914/6 944 S/S2/Turbo Type 944 959 968 Type 968	July/1994 Jan/1963	Sept/1997 Nov/1990	15 15	7	M1	5X130	71,5		0-PN0737SC*	Y
				16	M1	5X130	71,5		0-P1637S	G
	July/1994 Jan/1969	Sept/1997 Feb/1976	15 7-15	16	M2b	5X130	71,5	M14X1,50	0-P16126C	
				20	M1	5X130	71,5		0-P2037S	F
	June/1981 Jan/1986	July/1991 Apr/1991	15 15	20	M2b	5X130	71,5	M14X1,50	0-P20126C	
				20	M4	5X130	71,5	M14X1,50	0-P2037CD	M-F
	June/1991 Nov/1995	Nov/1995	15 15	25	M4	5X130	71,5	M14X1,50	0-P2537CD	M
				30	M4	5X130	71,5	M14X1,50	0-P3037CD	M
	June/1991	Nov/1995	15 15	35	M4	5X130	71,5	M14X1,50	0-PN3537CD*	
				40	M4	5X130	71,5	M14X1,50	0-PN4037CD*	
June/1991	Nov/1995	15 15	50	M4	5X130	71,5	M14X1,50	0-PN5037CD*		
Macan Type 95B	Feb/2014	>	14	5	M1	5X112	66,45		0-P0516S	A-Y
				5	M2a	5X112	66,45	M14X1,50	0-P0524C	C-Y
				5	M3a	5X112	66,45	M14X1,50	0-P0570CS	B-Y
				12	M1	5X112	66,45		0-P1216S	
				12	M2a	5X112	66,45	M14X1,50	0-P1224C	C
				12	M3a	5X112	66,45	M14X1,50	0-P1270CS	B
				16	M1	5X112	66,45		0-P1616S	
				16	M2a	5X112	66,45	M14X1,50	0-P1624C	C
				16	M3a	5X112	66,45	M14X1,50	0-P1670CS	B
				20	M1	5X112	66,45		0-P2016S	
				20	M2a	5X112	66,45	M14X1,50	0-P2024C	C
				20	M3a	5X112	66,45	M14X1,50	0-P2070CS	B
				25	M5	5X112	66,45	M14X1,50	0-P2524CD	
30	M5	5X112	66,45	M14X1,50	0-P3024CD					
924	1976	1988		30	M5	4x108	57	M14X1,50	0-PN30139CD*	

*DIAMOND FINISH / Finitura diamantata • Available in one week / Disponibile in una settimana

PORSCHE

MODELLO / MODEL	ANNO / YEAR DA / START A / END	NOTA CHIAVE KEY NOTE	SPESSORE THICKNESS (mm)	TIPO TYPE	INTERASSE C TO C	Ø	FILETTO THREAD	CODICE CODE #	NOTE NOTES	
Cayenne (P0356) Type 9YA-536 911 Type 992	2017 2018	>	1	5	M1	5X130	71,5		0-PN05142S*	H
				8	M1	5x130	71,5		0-PN08142S*	H
				10	M1	5x130	71,5		0-PN10142S*	H
				16	M1	5X130	71,5		0-P1637S	
				16	M3a	5X130	71,5	M14X1,50	0-P1637CS	N
				20	M1	5X130	71,5		0-P2037S	
				20	M3a	5X130	71,5	M14X1,50	0-P2037CS	N
				20	M5	5X130	71,5	M14X1,50	0-PN2092CD*	H
				25	M5	5X130	71,5	M14X1,50	0-P2592CD	H
				30	M5	5X130	71,5	M14X1,50	0-P3092CD	H
				35	M5	5X130	71,5	M14X1,50	0-PN3592CD*	H
				40	M5	5X130	71,5	M14X1,50	0-PN4092CD*	H
				50	M5	5X130	71,5	M14X1,50	0-PN5092CD*	H
				60	M5	5X130	71,5	M14X1,50	0-PN6092CD*	H
				70	M5	5X130	71,5	M14X1,50	0-PN7092CD*	H
80	M5	5X130	71,5	M14X1,50	0-PN8092CD*	H				
911 Type 992	2018	>	2	5	M1	5x130	71,5		0-PN05143S*	H
				8	M1	5x130	71,5		0-PN08143S*	H
				10	M1	5x130	71,5		0-PN10143S*	H
				16	M1	5X130	71,5		0-P1637S	
				16	M3a	5X130	71,5	M14X1,50	0-P1637CS	N
				20	M1	5X130	71,5		0-P2037S	
				20	M3a	5X130	71,5	M14X1,50	0-P2037CS	N
				20	M5	5X130	71,5	M14X1,50	0-PN2092CD*	H
				25	M5	5X130	71,5	M14X1,50	0-P2592CD	H
				30	M5	5X130	71,5	M14X1,50	0-P3092CD	H
				35	M5	5X130	71,5	M14X1,50	0-PN3592CD*	H
				40	M5	5X130	71,5	M14X1,50	0-PN4092CD*	H
				50	M5	5X130	71,5	M14X1,50	0-PN5092CD*	H
				60	M5	5X130	71,5	M14X1,50	0-PN6092CD*	H
				70	M5	5X130	71,5	M14X1,50	0-PN7092CD*	H
80	M5	5X130	71,5	M14X1,50	0-PN8092CD*	H				

RENAULT

MODELLO / MODEL	ANNO / YEAR DA / START A / END	NOTA CHIAVE KEY NOTE	SPESSORE THICKNESS (mm)	TIPO TYPE	INTERASSE C TO C	Ø	FILETTO THREAD	CODICE CODE #	NOTE NOTES
Clio I Type B/C57 Clio II Type BB0 Kangoo I 4 fori / holes Type KC Megane I Type DA Safrane I Type B54 Twingo I Type C06 Laguna I Type B56 / K56 Espace I / II Type J11 / J63 Alpine GT Type D501 / D502 / D503 R5 Type B - C40 - C40S R11 Type B - C37 R19 Type B - C37 R21 Type K48- L4	May/1990 Sept/1998 1997 1995 Apr/1992 May/1997 Nov/1993 July/1984 June/1980 1984 1981 1981 1986	Aug/1998 2004 2008 2002 July/1996 2007 Mar/2001 Oct/1996 Jan/1985 1996 1988 1988 1995	5	M1	4X100	60		0-P0519S	A-Y
			5	M2a	4X100	60	M12X1,50	0-P0519C	Y
			17	M1	4X100	60		0-P1719S	
			17	M2a	4X100	60	M12X1,50	0-P1719C	
			20	M1	4X100	60		0-P2019S	
			20	M2a	4X100	60	M12X1,50	0-P2019C	
			20	M5	4X100	60	M12X1,50	0-PN2019CD*	
			25	M5	4X100	60	M12X1,50	0-P2519CD	
			30	M5	4X100	60	M12X1,50	0-P3019CD	
			35	M5	4X100	60	M12X1,50	0-P3519CD	
			40	M5	4X100	60	M12X1,50	0-P4019CD	
			45	M5	4X100	60	M12X1,50	0-P4519CD	
			50	M5	4X100	60	M12X1,50	0-P5019CD	

*DIAMOND FINISH / Finitura diamantata • Available in one week / Disponibile in una settimana

RENAULT

MODELLO / MODEL	ANNO / YEAR DA / START A / END	NOTA CHIAVE KEY NOTE	SPESSORE THICKNESS (mm)	TIPO TYPE	INTERASSE C TO C	Ø	FILETTO THREAD	CODICE CODE #	NOTE NOTES	
Captur I Type X98 Clio III Type BR0/1-CR0/1 Clio IV Type X98 Clio IV Type R Clio V Type RJA Modus Type P Megane II Type DA NO RS Twingo I Type C06 Twingo II Type N Twingo III Type BCM Thalia Type B Wind Type N Zoe Type AG	Mar/2013 May/2005 Sept/2012 Sept/2012 2020 2004 2002 1993 2007 2014 Feb/1998 2010 2012	2019 Dec/2012 2020 2020 > 2012 Aug/2008 2007 2014 > Oct/2003 > >	6	5	M1	4X100	60		O-P0519S	A-Y
				5	M2a	4X100	60	M12X1,50	O-P0519C7	B-Y
				17	M1	4X100	60		O-P1719S	
				17	M2a	4X100	60	M12X1,50	O-P1719C7	B
				20	M1	4X100	60		O-P2019S	
				20	M2a	4X100	60	M12X1,50	O-P2019C7	B
				20	M5	4X100	60	M12X1,50	O-PN2019CD*	
				25	M5	4X100	60	M12X1,50	O-P2519CD	
				30	M5	4X100	60	M12X1,50	O-P3019CD	
				35	M5	4X100	60	M12X1,50	O-P3519CD	
				40	M5	4X100	60	M12X1,50	O-P4019CD	
				45	M5	4X100	60	M12X1,50	O-P4519CD	
				50	M5	4X100	60	M12X1,50	O-P5019CD	
				Be Pop Type W Clio V6 Phase 1 Type B-V6 1 Clio V6 Phase 2 Type B-V6 2 Kangoo II Type W Laguna II Type G Scenic II Type JM	2009 2000 2002 2008 Mar/2001 2003	> 2002 2005 > Oct/2007 May/2009		17	M1	5X108
17	M2a	5X108	60					M12X1,50	O-P1762C	
20	M1	5X108	60						O-P2028S	
20	M2a	5X108	60					M12X1,50	O-P2062C	
30	M5	5X108	60					M12X1,50	O-PN3062CD*	
35	M5	5X108	60					M12X1,50	O-PN3562CD*	
45	M5	5X108	60					M12X1,50	O-PN4562CD*	
Clio III 2.0 16V Sport RS Type R Megane II RS Type M Laguna Type B56 / K56 Vel Satis Type J Avantime Type DE Safrane II Type B54 Espace III Type JE Espace IV Type JKO Megane Scenic II Type JA RX4 Type JA	Aug/2005 2003 Nov/1993 2002 Sept/2001 Aug/1996 Nov/1996 Nov/2002 2003 Nov/2000	Sept/2012 June/2009 Mar/2001 Dec/2009 May/2003 Dec/2000 Oct/2002 2014 May/2009 Aug/2003		17	M1	5X108	60		O-P1728S	
				17	M2a	5X108	60	M14X1,50	O-P1728C	
				20	M1	5X108	60		O-P2028S	
				20	M2a	5X108	60	M14X1,50	O-P2028C	
				20	M5	5X108	60	M14X1,50	O-PN2028CD*	
				30	M5	5X108	60	M14X1,50	O-PN3028CD*	
				35	M5	5X108	60	M14X1,50	O-PN3528CD*	
				40	M5	5X108	60	M14X1,50	O-PN4028CD*	
				50	M5	5X108	60	M14X1,50	O-PN5028CD*	
Laguna III Type T Laguna III Sportour Type T Espace Type RFC Trafic III Type L2H1	Nov/2007 2008 2015 2014	2015 2015 > >		5	M1	5X114,3	66		O-P0553S	A-Y
				17	M1	5X114,3	66		O-P1775S	
				17	M2a	5X114,3	66	M14X1,50	O-P1775C	
				20	M1	5X114,3	66		O-P2075S	
				20	M2a	5X114,3	66	M14X1,50	O-P2075C	
				20	M5	5X114,3	66	M14X1,50	O-PN2075CD*	
				22	M2a	5X114,3	66	M14X1,50	O-PN2275C*	
				25	M5	5X114,3	66	M14X1,50	O-PN2575CD*	
				30	M5	5X114,3	66	M14X1,50	O-PN3075CD*	
				40	M5	5X114,3	66	M14X1,50	O-PN4075CD*	
				50	M5	5X114,3	66	M14X1,50	O-PN5075CD*	

RENAULT

MODELLO / MODEL	ANNO / YEAR DA / START A / END	NOTA CHIAVE KEY NOTE	SPESSORE THICKNESS (mm)	TIPO TYPE	INTERASSE C TO C	Ø	FILETTO THREAD	CODICE CODE #	NOTE NOTES	
Alpine A110 II Type A110 II Clio IV RS Type X98 Captur II Type RJB Kadjar Type RFE Scenic III Type JZ Scenic IV Type J9 Megane III Type Z Megane IV Type RFB Talisman Type RFD	2017 June/2013 2019 2015 June/2009 2016 Sept/2008 2016 2015	> > > > > > > > > > > >	7	5	M1	5X114,3	66		O-P0553S	A-Y
				5	M2a	5X114,3	66	M12X1,50	O-P0576C	
				17	M1	5X114,3	66		O-P1775S	
				17	M2a	5X114,3	66	M12X1,50	O-P1776C	
				20	M1	5X114,3	66		O-P2075S	
				20	M2a	5X114,3	66	M12X1,50	O-P2076C	
				20	M5	5X114,3	66	M12X1,50	O-PN2076CD*	
				30	M5	5X114,3	66	M12X1,50	O-PN3076CD*	
				35	M5	5X114,3	66	M12X1,50	O-PN3576CD	
				40	M5	5X114,3	66	M12X1,50	O-PN4076CD*	
				45	M5	5X114,3	66	M12X1,50	O-PN4576CD*	
				50	M5	5X114,3	66	M12X1,50	O-PN5076CD*	
				Koleos Type Y Koleos Type RZG	June/2008 2016	2016 >		16	M1	5X114,3
16	M1	5X114,3	66						O-P1653S	
16	M2b	5X114,3	66					M12X1,25	O-P1653C	I
20	M1	5X114,3	66						O-P2053S	
20	M2b	5X114,3	66					M12X1,25	O-P2053C	I
20	M4	5X114,3	66					M12X1,25	O-P2053CD	M
Trafic II Type FL - JL	2001	2014		5	M1	5X118	71	M14X1,5	O-PN05103S*	
				25	M5	5X118	71	M14X1,5	O-PN25103CD*	
				30	M5	5X118	71	M14X1,5	O-PN30103CD*	
Master II Type FD-HD-JD-ND-UD Master III Type MA-MB-ML	1997 2010	2010 >		30	M5	5x130	89	M14X1,5	O-PN30145CD*	H
				60	M5	5x130	89	M14X1,5	O-PN60145CD*	H

RENAULT (Off-road)

Alaskan Type D231C	2017	>		30	M4	6X114,3	66	M12X1,25	O-PFSN330	M-H
				40	M4	6X114,3	66	M12X1,25	O-PNFSN340*	H

ROVER

MODELLO / MODEL	ANNO / YEAR DA / START A / END	NOTA CHIAVE KEY NOTE	SPESSORE THICKNESS (mm)	TIPO TYPE	INTERASSE C TO C	Ø	FILETTO THREAD	CODICE CODE #	NOTE NOTES	
25 Type F / RT 45 Type T / RT MG ZR / ZS - Type RT/F 200 Type RF/RT 400 Type XW	1999 1999 2002 Mar/1985 Apr/1990	2005 2005 2005 Mar/2000 Mar/2000		5	M1	4X100	56		O-P0539S	A-Y
				12	M1	4X100	56		O-P1239S	
				12	M2b	4X100	56	M12X1,50	O-P1213C	0
				16	M1	4X100	56		O-P1639S	
				16	M2b	4X100	56	M12X1,50	O-P1613C	0
				20	M1	4X100	56		O-P2039S	
				20	M2b	4X100	56	M12X1,50	O-P2013C	0
75 Type RJ	1999	2005		20	M1	5X100	56		O-PN2050S*	
				20	M4	4X100	56	M12X1,50	O-P2013CD	M
600, 623 Type RH 820, 825, 827 Type RS-XS	1993 1987	1999 1999		30	M1	4x114,3	64		O-PN2029S*	NEW
				20	M4	4x114,3	64	M12x1,50	O-PN2029CD*	NEW
				30	M4	4x114,3	64	M12X1,5	O-PN3029CD*	
				35	M4	4x114,3	64	M12x1,50	O-PN3529CD	NEW
				40	M4	4x114,3	64	M12X1,5	O-PN4029CD*	NEW

*DIAMOND FINISH / Finitura diamantata • Available in one week / Disponibile in una settimana

SAAB

MODELLO / MODEL	ANNO / YEAR DA / START A / END	NOTA CHIAVE KEY NOTE	SPESSORE THICKNESS (mm)	TIPO TYPE	INTERASSE C TO C	Ø	FILETTO THREAD	CODICE CODE #	NOTE NOTES
900 Type YS3D 9.3 Type YS3D 9.3 Type YS3F 9.5 Type YS3E	July/1993 Sept/1997 Aug/2003 Sept/1997	Feb/1998 Aug/2003 2011 2010	5	M1	5X110	65		0-P0540S	A-Y
			5	M2a	5X110	65	M12X1,50	0-P0540C	Y
			17	M1	5X110	65		0-P1740S	
			17	M2a	5X110	65	M12X1,50	0-P1740C	
			20	M1	5X110	65		0-P2040S	
			20	M2a	5X110	65	M12X1,50	0-P2040C	

SEAT

MODELLO / MODEL	ANNO / YEAR DA / START A / END	NOTA CHIAVE KEY NOTE	SPESSORE THICKNESS (mm)	TIPO TYPE	INTERASSE C TO C	Ø	FILETTO THREAD	CODICE CODE #	NOTE NOTES
Arosa Type 6H / 6HS Cordoba Type 6K Ibiza II - III Type 6K Ibiza Cupra Type 6K Toledo Type 1L Mii Type AA	May/1997 Mar/1993 Mar/1993 July/2000 Jan/1991 Nov/2011	June/2004 Feb/2002 Feb/2002 Feb/2002 Mar/1999 >	5	M1	4X100	57		0-P0526S	A-Y
			5	M2a	4X100	57	M12X1,50	0-P0526C	C-Y
			5	M3a	4X100	57	M12X1,50	0-P0526CS	B-Y
			12	M1	4X100	57		0-P1226S	
			12	M2a	4X100	57	M12X1,50	0-P1226C	C
			12	M3a	4X100	57	M12X1,50	0-P1226CS	B
			17	M1	4X100	57		0-P1726S	
			17	M2a	4X100	57	M12X1,50	0-P1726C	C
			17	M3a	4X100	57	M12X1,50	0-P1726CS	B
			20	M1	4X100	57		0-P2026S	
			20	M2a	4X100	57	M12X1,50	0-P2026C	C
			20	M3a	4X100	57	M12X1,50	0-P2026CS	B
			25	M5	4X100	57	M12X1,50	0-P2526CD	
			30	M5	4X100	57	M12X1,50	0-P3026CD	
			35	M5	4X100	57	M12X1,50	0-P3526CD	
			40	M5	4X100	57	M12X1,50	0-P4026CD	
45	M5	4X100	57	M12X1,50	0-P4526CD				
50	M5	4X100	57	M12X1,50	0-P5026CD				
Arona Type P Cordoba III Type 6L Ibiza IV Type 6L Ibiza V Type 6J Ibiza VI Type 6P Ibiza VII Type KJ - 6F Leon I Type 1M Leon I Cupra R Type 1M Toledo I 2.0 16V Type 1L Toledo II Type 1M Toledo IV Type NH	2017 Oct/2002 2002 May/2008 2015 2017 2017 Nov/1999 Nov/1999 1991 1999 July/2012	> Nov/2009 Apr/2008 2015 2017 > Aug/2005 Aug/2005 1999 Oct/2004 >	5	M1	5X100	57		0-P0527S	A-Y
			5	M2a	5X100	57	M14X1,50	0-P0527C	C-Y
			5	M3a	5X100	57	M14X1,50	0-P0527CS	B-Y
			10	M1	5x100	57		0-P10270ES	Z
			12	M1	5X100	57		0-P1227S	
			12	M2a	5X100	57	M14X1,50	0-P1227C	C
			12	M3a	5X100	57	M14X1,50	0-P1227CS	B
			16	M1	5X100	57		0-P1627S	
			16	M2a	5X100	57	M14X1,50	0-P1627C	C
			16	M3a	5X100	57	M14X1,50	0-P1627CS	B
			20	M1	5X100	57		0-P2027S	
			20	M2a	5X100	57	M14X1,50	0-P2027C	C
			20	M3a	5X100	57	M14X1,50	0-P2027CS	B
			20	M5	5X100	57	M14X1,50	0-PN2027CD*	
			25	M5	5X100	57	M14X1,50	0-P2527CD	
			30	M5	5X100	57	M14X1,50	0-P3027CD	
35	M5	5X100	57	M14X1,50	0-P3527CD				
40	M5	5X100	57	M14X1,50	0-PN4027CD*				

SEAT

MODELLO / MODEL	ANNO / YEAR DA / START A / END	NOTA CHIAVE KEY NOTE	SPESSORE THICKNESS (mm)	TIPO TYPE	INTERASSE C TO C	Ø	FILETTO THREAD	CODICE CODE #	NOTE NOTES	
Ateca Type 5FP Alhambra Type 7MS Alhambra Type 7N Altea Type 5P Exeo Type 3R Leon / Leon Cupra Type 1P Leon / Leon Cupra Type 5F Leon / Leon Cupra Type KL Tarraco Type KN Toledo III Type 5P	2016 Apr/1996 2010 June/2004 Apr/2009 2006 Apr/2013 Apr/2013 2020 2020 2018 Jan/2004	> > > > > > > > > > > > > > > > > > >	5	M1	5X112	57		O-P0506S	A-Y	
			5	M2a	5X112	57	M14X1,50		O-P0506C	C-Y
			5	M3a	5X112	57	M14X1,50		O-P0506CS	B-Y
			12	M1	5X112	57			O-P1206S	
			12	M2a	5X112	57	M14X1,50		O-P1206C	C
			12	M3a	5X112	57	M14X1,50		O-P1206CS	B
			10	M1	5x112	57			O-P1006OES	Z
			13	M1	5x112	57			O-P1306OES	Z
			16	M1	5X112	57			O-P1606S	
			16	M2a	5X112	57	M14X1,50		O-P1606C	C
			16	M3a	5X112	57	M14X1,50		O-P1606CS	B
			20	M1	5X112	57			O-P2006S	
			20	M2a	5X112	57	M14X1,50		O-P2006C	C
			20	M3a	5X112	57	M14X1,50		O-P2006CS	B
			20	M5	5X112	57	M14X1,50		O-PN2006CD*	
			25	M5	5X112	57	M14X1,50		O-P2506CD	
			30	M5	5X112	57	M14X1,50		O-P3006CD	
			35	M5	5X112	57	M14X1,50		O-P3506CD	
			40	M5	5X112	57	M14X1,50		O-P4006CD	
50	M5	5X112	57	M14X1,50		O-PN5006CD*				

SKODA

MODELLO / MODEL	ANNO / YEAR DA / START A / END	NOTA CHIAVE KEY NOTE	SPESSORE THICKNESS (mm)	TIPO TYPE	INTERASSE C TO C	Ø	FILETTO THREAD	CODICE CODE #	NOTE NOTES	
Citigo Type AA Citigo Type NF1	Nov/2011 2019	> >	5	M1	4X100	57		O-P0526S	A-Y	
			5	M2a	4X100	57	M12X1,50		O-P0526C	C-Y
			5	M3a	4X100	57	M12X1,50		O-P0526CS	B-Y
			12	M1	4X100	57			O-P1226S	
			12	M2a	4X100	57	M12X1,50		O-P1226C	C
			12	M3a	4X100	57	M12X1,50		O-P1226CS	B
			17	M1	4X100	57			O-P1726S	
			17	M2a	4X100	57	M12X1,50		O-P1726C	C
			17	M3a	4X100	57	M12X1,50		O-P1726CS	B
			20	M1	4X100	57			O-P2026S	
			20	M2a	4X100	57	M12X1,50		O-P2026C	C
			20	M3a	4X100	57	M12X1,50		O-P2026CS	B
			25	M5	4X100	57	M12X1,50		O-P2526CD	
			30	M5	4X100	57	M12X1,50		O-P3026CD	
			35	M5	4X100	57	M12X1,50		O-P3526CD	
			40	M5	4X100	57	M12X1,50		O-P4026CD	
			45	M5	4X100	57	M12X1,50		O-P4526CD	
50	M5	4X100	57	M12X1,50		O-P5026CD				

*DIAMOND FINISH / Finitura diamantata • Available in one week / Disponibile in una settimana

SKODA

MODELLO / MODEL	ANNO / YEAR DA / START A / END	NOTA CHIAVE KEY NOTE	SPESSORE THICKNESS (mm)	TIPO TYPE	INTERASSE C TO C	Ø	FILETTO THREAD	CODICE CODE #	NOTE NOTES	
Fabia I Type 6Y Fabia II Type 5J Fabia III Type 5J Octavia I Type 1U Kamiq Type NW Praktik Type 5J Roomster Type 5J Rapid Type 6R Scala Type NW	Aug/1999 July/2010 2014 1996 2019 2008 Sept/2006 July/2012 2019	Mar/2008 2014 > 2003 > > 2015 > >	5	M1	5X100	57		0-P0527S	A-Y	
			5	M2a	5X100	57	M14X1,50		0-P0527C	C-Y
			5	M3a	5X100	57	M14X1,50		0-P0527CS	B-Y
			10	M1	5x100	57			0-P1027OES	Z
			12	M1	5X100	57			0-P1227S	
			12	M2a	5X100	57	M14X1,50		0-P1227C	C
			12	M3a	5X100	57	M14X1,50		0-P1227CS	B
			16	M1	5X100	57			0-P1627S	
			16	M2a	5X100	57	M14X1,50		0-P1627C	C
			16	M3a	5X100	57	M14X1,50		0-P1627CS	B
			20	M1	5X100	57			0-P2027S	
			20	M2a	5X100	57	M14X1,50		0-P2027C	C
			20	M3a	5X100	57	M14X1,50		0-P2027CS	B
			20	M5	5X100	57	M14X1,50		0-PN2027CD*	
			25	M5	5X100	57	M14X1,50		0-P2527CD	
			30	M5	5X100	57	M14X1,50		0-P3027CD	
35	M5	5X100	57	M14X1,50		0-P3527CD				
40	M5	5X100	57	M14X1,50		0-PN4027CD*				
Karoq Type NU Kodiaq Type NS Octavia II Type 1Z Octavia III Type 5E Octavia IV Inkl. RS Type NX Superb Type 3U Superb Type 3T Superb Type 3T - 3V Yeti Type 5L	2017 2016 2004 2013 2020 2001 2008 2008 2015 Oct/2009	> > 2013 2020 > 2008 2015 > 2017	5	M1	5X112	57		0-P0506S	A-Y	
			5	M2a	5X112	57	M14X1,50		0-P0506C	C-Y
			5	M3a	5X112	57	M14X1,50		0-P0506CS	B-Y
			12	M1	5X112	57			0-P1206S	
			12	M2a	5X112	57	M14X1,50		0-P1206C	C
			12	M3a	5X112	57	M14X1,50		0-P1206CS	B
			10	M1	5x112	57			0-P1006OES	Z
			13	M1	5x112	57			0-P1306OES	Z
			16	M1	5X112	57			0-P1606S	
			16	M2a	5X112	57	M14X1,50		0-P1606C	C
			16	M3a	5X112	57	M14X1,50		0-P1606CS	B
			20	M1	5X112	57			0-P2006S	
			20	M2a	5X112	57	M14X1,50		0-P2006C	C
			20	M3a	5X112	57	M14X1,50		0-P2006CS	B
			20	M5	5X112	57	M14X1,50		0-PN2006CD*	
			25	M5	5X112	57	M14X1,50		0-P2506CD	
			30	M5	5X112	57	M14X1,50		0-P3006CD	
			35	M5	5X112	57	M14X1,50		0-P3506CD	
40	M5	5X112	57	M14X1,50		0-P4006CD				
50	M5	5X112	57	M14X1,50		0-PN5006CD*				

SMART by MERCEDES

MODELLO / MODEL	ANNO / YEAR DA / START A / END	NOTA CHIAVE KEY NOTE	SPESSORE THICKNESS (mm)	TIPO TYPE	INTERASSE C TO C	Ø	FILETTO THREAD	CODICE CODE #	NOTE NOTES
Fortwo Type 453 Forfour Type 453 - 451 Brabus Type 453 - 451	July/2014 July/2014 2014	> > >	5	M1	4X100	60		0-P0519S	A-Y
			17	M1	4X100	60		0-P1719S	
			20	M1	4X100	60		0-P2019S	
			5	M2a	4X100	60	M12X1,50	0-P0519C7	B-Y
			17	M2a	4X100	60	M12X1,50	0-P1719C7	B
			20	M2a	4X100	60	M12X1,50	0-P2019C7	B
			25	M5	4X100	60	M12X1,50	0-P2519CD	
			30	M5	4X100	60	M12X1,50	0-P3019CD	
			35	M5	4X100	60	M12X1,50	0-P3519CD	
			40	M5	4X100	60	M12X1,50	0-P4019CD	
			45	M5	4X100	60	M12X1,50	0-P4519CD	
			50	M5	4X100	60	M12X1,50	0-P5019CD	
Fortwo Type 450 - MC01 Roadster Type 452 Fortwo Type 451 Fortwo Type 452	July/1998 Apr/2003 July/2003 Jan/2007	Jan/2007 June/2014 Jan/2007 June/2014	5	M1	3X112	57		0-PN0525S*	
			10	M3a	3X112	57		0-PN1025CS*	
			15	M1	3X112	57		0-P1525S	
			20	M1	3X112	57		0-P2025S	
			15	M2a	3X112	57	M12X1,50	0-P1525C	C
			20	M2a	3X112	57	M12X1,50	0-P2025C	C
			15	M3a	3X112	57	M12X1,50	0-P1525CS	B
			20	M3a	3X112	57	M12X1,50	0-P2025CS	B
			25	M5	3X112	57	M12X1,50	0-PN2525CD*	
			30	M5	3X112	57	M12X1,50	0-PN3025CD*	
			35	M5	3X112	57	M12X1,50	0-PN3525CD*	
			40	M5	3X112	57	M12X1,50	0-PN4025CD*	
			45	M5	3X112	57	M12X1,50	0-PN4525CD*	
			50	M5	3X112	57	M12X1,50	0-PN5025CD*	
80	M5	3X112	57	M12X1,50	0-PN8025CD*				
Smart Forfour Type 454	2004	2006	16	M1	4X114,3	67		0-P1611S	
			20	M1	4X114,3	67		0-P2011S	
			16	M2b	4X114,3	67	M12X1,50	0-P1611C	L
			20	M2b	4X114,3	67	M12X1,50	0-P2011C	L
			20	M4	4X114,3	67	M12X1,50	0-P2011CD	M

SSANGYONG

MODELLO / MODEL	ANNO / YEAR DA / START A / END	NOTA CHIAVE KEY NOTE	SPESSORE THICKNESS (mm)	TIPO TYPE	INTERASSE C TO C	Ø	FILETTO THREAD	CODICE CODE #	NOTE NOTES	
Korando Type KJ Musso Type FJ Rexton I Type RJ	Dec/1996 Feb/1995 2005	2011 Jan/1999 June/2006	30	M4	6X139,7	108	M12X1,50	0-PFSM130	M-Y	
			40	M4	6X139,7	108	M12X1,50	0-PNFSM140*	Y	
			50	M4	6X139,7	108	M12X1,50	0-PNFSM150*	Y	
			60	M4	6X139,7	108	M12X1,50	0-PNFSM160* NEW	Y	
Actyon Type CJ Actyon Sport Type QJ Kyron Type DJ Musso Type QK Rexton II Type RJ Rexton III Type YK Rodius I Type RD	Dec/2006 Dec/2006 2006 2018 July/2006 2017 May/2005	> > > > 2016 > 2013	7 7	30	M4	5X130	84	M14X1,50	0-PFSV230	M-H
				35	M4	5X130	84	M14X1,50	0-PFSV235	M-H
				40	M4	5X130	84	M14X1,50	0-PFSV240	H

*DIAMOND FINISH / Finitura diamantata • Available in one week / Disponibile in una settimana

SSANGYONG

MODELLO / MODEL	ANNO / YEAR DA / START A / END	NOTA CHIAVE KEY NOTE	SPESSORE THICKNESS (mm)	TIPO TYPE	INTERASSE C TO C	Ø	FILETTO THREAD	CODICE CODE #	NOTE NOTES
Tivoli Type XK XLV Type E-XKG160, E-XDI160	2015 2016	> >	20	M3A	5x112	66,45	M12X1,5	0-P2016KO	
			20	M4	5X112	66,5	M12X1,50	0-PN2016CD*	
			25	M5	5X112	66,5	M12X1,50	0-P2516CD	Q
			30	M5	5X112	66,5	M12X1,50	0-P3016CD	Q
			35	M5	5X112	66,5	M12X1,50	0-PN3516CD*	
			40	M5	5X112	66,5	M12X1,50	0-PN4016CD*	
			50	M5	5X112	66,5	M12X1,50	0-PN5016CD*	
			60	M5	5X112	66,5	M12X1,50	0-PN6016CD*	

SUBARU

MODELLO / MODEL	ANNO / YEAR DA / START A / END	NOTA CHIAVE KEY NOTE	SPESSORE THICKNESS (mm)	TIPO TYPE	INTERASSE C TO C	Ø	FILETTO THREAD	CODICE CODE #	NOTE NOTES	
Justy Type NH	2003	Oct/2007	5	M1	4X100	54		0-PN0514S*	A-Y	
			16	M1	4X100	54		0-P1614S		
			16	M2a	4X100	54	M12X1,50	0-P1665C	C	
			16	M2a	4X100	54	M12X1,50	0-P16112C	U	
			20	M1	4X100	54		0-P2014S		
			20	M2a	4X100	54	M12X1,50	0-P2065C	C	
Outback Type BL/BP BRZ Type CZ Impreza Type G4 Impreza Type MY08 G3 / G3S Impreza Type GC/GF/GFC/GG/GD/GDI Forester Type SG Forester Type SH Legacy Type BL/BP XV Type G4 Trezia Type D1 (A)	2003 2012 Jan/2013 Oct/2007 Aug/1992 2002 July/2008 2003 2011 Apr/2011	2014 > > Dec/2012 Dec/2004 June/2008 > 2014 > >	5	M1	5X100	56		0-PN0533S*	A-Y	
			16	M1	5X100	56		0-P1633S		
			16	M2b	5X100	56	M12X1,25	0-P1633C	I	
			20	M1	5X100	56		0-P2033S		
			20	M2b	5X100	56	M12X1,25	0-P2033C	I	
			20	M4	5X100	56	M12X1,25	0-P2033CD	M	
			25	M4	5X100	56	M12X1,25	0-PN2533CD*	M	
			30	M4	5X100	56	M12X1,25	0-PN3033CD*	M	
			35	M4	5X100	56	M12X1,25	0-PN3533CD*		
			40	M4	5X100	56	M12X1,25	0-PN4033CD*		
			50	M4	5X100	56	M12X1,25	0-PN5033CD*		
Impreza STI WRX Type V1 Impreza STI WRX Type GD / GG Impreza STI WRX Type G3 / G3S Levorg B9 Tribeca Type WX	Jan/2015 Jan/2005 Mar/2008 2015 2006	> Feb/2008 June/2014 > >	16	16	16	16	16	16	16	
			5	M1	5X114,3	56		0-PN0573S*		
			16	M1	5X114,3	56		0-P1673S		
			16	M2b	5X114,3	56	M12X1,25	0-P1673C	I	
			20	M1	5X114,3	56		0-P2073S		
			20	M2b	5X114,3	56	M12X1,25	0-P2073C	I	
			20	M4	5X114,3	56	M12X1,25	0-P2073CD	M	
			25	M4	5X114,3	56	M12X1,25	0-PN2573CD*	M	
			30	M4	5X114,3	56	M12X1,25	0-PN3073CD*	M	
			35	M4	5X114,3	56	M12X1,25	0-PN3573CD*		
40	M4	5X114,3	56	M12X1,25	0-PN4073CD*					
50	M4	5X114,3	56	M12X1,25	0-PN5073CD*					

*DIAMOND FINISH / Finitura diamantata • Available in one week / Disponibile in una settimana

SUZUKI

MODELLO / MODEL	ANNO / YEAR DA / START A / END	NOTA CHIAVE KEY NOTE	SPESSORE THICKNESS (mm)	TIPO TYPE	INTERASSE C TO C	Ø	FILETTO THREAD	CODICE CODE #	NOTE NOTES	
Ignis Type MH Swift III Type MZ -EZ Swift IV Type FZ - NZ Splash Type EX	2004 May/2005 2010 2008	2008 May/2010 2017 2014	5	M1	4X100	54		0-PN0514S*		
			16	M1	4X100	54		0-P1614S		
			20	M1	4X100	54		0-P2014S		
			16	M2a	4X100	54	M12X1,50	0-P1665C	C	
			20	M2a	4X100	54	M12X1,50	0-P2065C	C	
			16	M2a	4X100	54	M12X1,50	0-P16112C	U	
			20	M2a	4X100	54	M12X1,50	0-P20112C	U	
35	M5	4X100	54	M12X1,50	0-PN3565CD*					
Alto II Type FF Baleno I Type EG Baleno II Type FW - EW Ignis III Type MF Liana Type ER Swift Type AZ - RZ Wagon R Type FM-MM-H00	2002 1995 2015 2017 2001 2017 1997	2006 2001 > > 2007 > 2006	6	20	M4	4X100	54	M12X1,25	0-P2048CD NEW	M-H
Swift Sport Type MZ - EZ Swift Sport Type NZ - FZ Vitara Type LY SX4 I Type EY / GY SX4 II S Cross	Jan/2007 Nov/2011 Feb/2015 June/2006 Oct/2013	Oct/2011 2017 > Sept/2013 >	7 7	16	M1	5X114,3	60		0-P1667S	
				20	M1	5X114,3	60		0-P2067S	
				16	M2a	5X114,3	60	M12X1,50	0-P1668C	
				20	M2a	5X114,3	60	M12X1,50	0-P2068C	
30	M5	5X114,3	60	M12X1,50	0-P3068CD					
Kizashi Type FR Swift Sport 1.4 Type AZ	2009 2017	2016 >	7	20	M4	5X114,3	60	M12x1,25	0-P2009CD NEW	M
Alto Type EF Swift Type AA - AH - AJ Swift Type EA - MA	1994 1983 1991	2002 1989 2004	6 6	16	M1	4X114,3	60		0-PN1657S*	
				35	M4	4X114,3	60	M12x1,25	0-PN3557CD*	

SUZUKI (Off-road)

Vitara Type ET / TA Grand Vitara Type FT / GT SJ Type 410 / 413 Samurai Type SJ Jimny Type FJ Jimny Type A6G-GJ X-90 Type EL	July/1988 Mar/1998 Sept/1981 Nov/1988 Sept/1988 2018 Sept/1995	Oct/2002 Mar/2005 Aug/1990 2004 2018 > 1998		30	M4	5X139,7	108	M12X1,25	0-PFSS130	Y
				35	M4	5X139,7	108	M12X1,25	0-PNFSS135*	Y
				40	M4	5X139,7	108	M12X1,25	0-PNFSS140*	Y
				50	M4	5X139,7	108	M12X1,25	0-PNFSS150*	Y
Grand Vitara Type JT	2006	2015		30	M4	5X114,3	60	M12X1,25	0-PFSS230	H
				35	M4	5X114,3	60	M12X1,25	0-PNFSS235*	H
				40	M4	5X114,3	60	M12X1,25	0-PNFSS240*	H

TESLA

MODELLO / MODEL	ANNO / YEAR DA / START A / END	NOTA CHIAVE KEY NOTE	SPESSORE THICKNESS (mm)	TIPO TYPE	INTERASSE C TO C	Ø	FILETTO THREAD	CODICE CODE #	NOTE NOTES	
Model S Type 002 Model X Type 002 - Model X	2012 2016	> >		20	M4	5x120	64	M14X1,50	0-PN20131CD* NEW	M
				30	M4	5x120	64	M14X1,50	0-PN30131CD*	M
Model 3 Type 003 Model 3 Performance Type 003 Model Y Type 003	2017 2017 2020	> > >		20	M4	5x114,3	64	M14X1,50	0-PN20147CD* NEW	M

*DIAMOND FINISH / Finitura diamantata • Available in one week / Disponibile in una settimana

TOYOTA

Carina II Type T15	1983	1987		5	M1	4X100	54		O-PN0514S*				
Carina II Type T17	1987	1993		16	M1	4X100	54		O-P1614S				
Carina E Type T19/T19U	Apr/1992	Sept/1997		16	M2b	4X100	54	M12X1,50	O-P1614C	L			
Celica Type T16 / T18C/T18F	Sept/1985	Jan/1994		20	M1	4X100	54		O-P2014S				
Corolla Type E8/E8B/E9/ E10/E11/E12	June/1983	May/2004		20	M2b	4X100	54	M12X1,50	O-P2014C	L			
Yaris Type P1	1999	2005		20	M4	4X100	54	M12X1,50	O-P2014CD	M			
Yaris Type XP9	2006	2011		30	M4	4X100	54	M12X1,50	O-PN3014CD*	M			
Yaris Type XP13	2011	2020		35	M4	4X100	54	M12X1,50	O-PN3514CD*				
Yaris verso Type P/7P2/P1F	Nov/1999	2005		40	M4	4X100	54	M12X1,50	O-PN4014CD*				
iQ Type AJ1	Feb/2009	>		50	M4	4X100	54	M12X1,50	O-PN5014CD*				
MR2 Type W10	1984	1989											
MR2 Type W30	2000	2005											
Aygo Type AB1	July/2005	>		5	M1	4X100	54		O-PN0514S*				
				16	M1	4X100	54		O-P1614S				
				16	M2a	4X100	54	M12X1,50	O-P1665C	C			
				16	M2a	4X100	54	M12X1,50	O-P16112C	U			
				20	M1	4X100	54		O-P2014S				
				20	M2a	4X100	54	M12X1,50	O-P2065C	C			
				20	M2a	4X100	54	M12X1,50	O-P20112C	U			
GT 86 Coupé Type ZN6	Mar/2012	>		5	M1	5X100	56		O-PN0533S*				
				16	M1	5X100	56		O-P1633S				
				16	M2b	5X100	56	M12X1,25	O-P1633C	I			
				20	M1	5X100	56		O-P2033S				
				20	M2b	5X100	56	M12X1,25	O-P2033C	I			
				20	M4	5X100	56	M12X1,25	O-P2033CD	M			
				25	M4	5X100	56	M12X1,25	O-PN2533CD*	M			
				30	M4	5X100	56	M12X1,25	O-PN3033CD*	M			
				35	M4	5X100	56	M12X1,25	O-PN3533CD*				
				40	M4	5X100	56	M12X1,25	O-PN4033CD*				
50	M4	5X100	56	M12X1,25	O-PN5033CD*								
Supra Type A90 JTSC/JBSC	2019	>		5	M1	5X112	66,45		O-P0516S	A-Y			
				5	M2a	5X112	66,45	M14X1,25	O-P0543C	Y			
				12	M1	5X112	66,45		O-P1216S				
				12	M2a	5X112	66,45	M14X1,25	O-P1243C				
				16	M1	5X112	66,45		O-P1616S				
				16	M2a	5X112	66,45	M14X1,25	O-P1643C				
				20	M1	5X112	66,45		O-P2016S				
				20	M2a	5X112	66,45	M14X1,25	O-P2043C				
				20	M2a	5X112	66,45	M14X1,25	O-PN2043CD*	NEW			
				25	M5	5X112	66,45	M14X1,25	O-P2543CD	NEW			
30	M5	5X112	66,45	M14X1,25	O-P3043CD	NEW							
Avensis Type T25 excl. 2.2 D CAT	Apr/2003	2009		16	M1	5X100	54		O-P1615S				
				16	M2b	5X100	54	M12X1,50	O-P1615C	L			
				20	M1	5X100	54		O-P2015S				
				20	M2b	5X100	54	M12X1,50	O-P2015C	L			
				20	M4	5X100	54	M12X1,50	O-P2015CD	M			
				25	M4	5X100	54	M12X1,50	O-PN2515CD*	M			
				30	M4	5X100	54	M12X1,50	O-PN3015CD*	M			
				35	M4	5X100	54	M12X1,50	O-PN3515CD*				
				40	M4	5X100	54	M12X1,50	O-PN4015CD*				
				45	M4	5X100	54	M12X1,50	O-PN4515CD*				
				Carina E Type T19	Apr/1992	Sept/1997							
				Camry Type V2	Oct/1986	June/1991							
Celica Type T16/T18F/T20/T23	Sept/1985	2005											
Prius Type HW2	2003	2009											
Prius Type HW3	2009	2016											
Prius Type ZVW5	2017	>											
Urban Cruiser Type XP11 (A)	2009	2014											
Yaris Type XP21 (NO GR Type XPA1G)	2020	>											

*DIAMOND FINISH / Finitura diamantata • Available in one week / Disponibile in una settimana

TOYOTA

MODELLO / MODEL	ANNO / YEAR DA / START	YEAR A / END	NOTA CHIAVE KEY NOTE	SPESSORE THICKNESS (mm)	TIPO TYPE	INTERASSE C TO C	Ø	FILETTO THREAD	CODICE CODE #	NOTE NOTES
Auris Type E15J	2007	2012		16	M1	5X114,3	60		0-P1667S	
Auris Type HE18U (A)	2012	>		16	M2b	5X114,3	60	M12X1,50	0-P1667C	L
Auris Inkl. Hybrid Type E18UM (A)	2013	>		20	M1	5X114,3	60		0-P2067S	
Avensis 2.2 D CAT Type T25	Apr/2003	2009		20	M2b	5X114,3	60	M12X1,50	0-P2067C	L
Avensis Type T27	2009	2017		20	M4	5X114,3	60	M12X1,50	0-P2067CD	M
Avensis Verso Type M2	2001	2003		25	M4	5X114,3	60	M12X1,50	0-PN2567CD*	M
Corolla Verso Type R1	2004	2009		30	M4	5X114,3	60	M12X1,50	0-P3067CD	M
Corolla Inkl. Hybrid Type E210 - ZE1HE	2018	>		35	M4	5X114,3	60	M12X1,50	0-PN3567CD*	
Camry Type V3	2001	2006		40	M4	5X114,3	60	M12X1,50	0-PN4067CD*	
MR2 Type W20	2000	2005		50	M4	5X114,3	60	M12X1,50	0-PN5067CD*	
Picnic Type XM1	May/1996	Jan/2001		55	M4	5X114,3	60	M12X1,50	0-PN5567CD*	
Previa Type R3	June/2000	2005		70	M4	5X114,3	60	M12X1,50	0-PN7067CD*	
Supra Type A7/A8	Jan/1986	Aug/1998								
C-HR Type AX1T-AX1T-TMG	2016	>								
Yaris GR Type XPA1G	2020	>								

TOYOTA (Off-road)

Land Cruiser J60	1981	1989		30	M4	6X139,7	108	M12X1,50	0-PFSM130	M-Y
Land Cruiser J70	1984	1996		40	M4	6X139,7	108	M12X1,50	0-PNFSM140*	Y
Land Cruiser J80	1989	1998		50	M4	6X139,7	108	M12X1,50	0-PNFSM150*	Y
Hi-ace Excl. H10	<	2003		60	M4	6X139,7	108	M12X1,50	0-PNFSM160* NEW	Y
Hilux 4WD N1 / N16 / N17	1990	2005		25	M4	6X139,7	106	M12X1,50	0-PNFST225*	M-H
PICK UP- 4 Runner Type N13	1987	>		30	M4	6X139,7	106	M12X1,50	0-PFST230	M-H
Land Cruiser 90-95 Type J9	1999	1999		35	M4	6X139,7	106	M12X1,50	0-PNFST235*	M-H
Land Cruiser 120/125 Type J12	2002	2002		40	M4	6X139,7	106	M12X1,50	0-PNFST240*	M-H
Land Cruiser Type J15TM	2009	2009								
Hi-ace 2WD/4WD Type Hi-ace	2003	2003								
Hilux Type KUN25T	2005	2005								
Hilux Type KUN26T	2009	2009								
Hilux Type 8 Generation	2016	2016								
RAV 4 Type XA1 / XA	1994	2000		16	M1	5X114,30	60		0-P1667S	
RAV 4 Type XA2 / A2	2000	2006		16	M2b	5X114,30	60	M12X1,50	0-P1667C	L
RAV 4 Type XA3 / XA3 (A)	2006	2013		20	M1	5X114,30	60		0-P2067S	
RAV 4 Type XA4	2013	2018		20	M2b	5X114,30	60	M12X1,50	0-P2067C	L
RAV 4 Type XA5	2018	>		20	M4	5X114,30	60	M12X1,50	0-P2067CD	M-H
				30	M4	5X114,30	60	M12X1,50	0-P3067CD	M-H
Land Cruiser 100 Type J10	1998	1998		30	M4	5X150	110	M14X1,5	0-PNFST430*	Y
Land Cruiser 200 Type J20	2008	2008		35	M4	5X150	110	M14X1,5	0-PNFST435*	Y
Tundra Type K5-K6	2006	2006		50	M4	5X150	110	M14X1,5	0-PNFST450*	Y

VOLKSWAGEN

MODELLO / MODEL	ANNO / YEAR DA / START A / END	NOTA CHIAVE KEY NOTE	SPESSORE THICKNESS (mm)	TIPO TYPE	INTERASSE C TO C	Ø	FILETTO THREAD	CODICE CODE #	NOTE NOTES		
UP Type AA Corrado Type 53 I excl. 2.9i VR6 Golf I II III Type 17 excl. 2.0i GTI - 2.8i VR6 Jetta I II Type 16/19E Lupo Type 6 Passat Type 32B / 35B Polo I II III Type 86C Scirocco Type 53B Vento Type 1H2	Nov/2011 1995 1997 1999 1997 1999 1997 1999 1997 1999 1997 1999 1997 1999 1997 1999 1997 1999	> 1999 1997 1999 1997 1999 1997 1999 1997 1999 1997 1999 1997 1999 1997 1999 1997 1999	6 6 6 6 6 6 6 6 6 6 6 6 6 6 6 6 6	5	M1	4X100	57		0-P0526S	A-Y	
				5	M2a	4X100	57	M12X1,50		0-P0526C	C-Y
				5	M3a	4X100	57	M12X1,50		0-P0526CS	B-Y
				12	M1	4X100	57			0-P1226S	
				12	M2a	4X100	57	M12X1,50		0-P1226C	C
				12	M3a	4X100	57	M12X1,50		0-P1226CS	B
				17	M1	4X100	57			0-P1726S	
				17	M2a	4X100	57	M12X1,50		0-P1726C	C
				17	M3a	4X100	57	M12X1,50		0-P1726CS	B
				20	M1	4X100	57			0-P2026S	
				20	M2a	4X100	57	M12X1,50		0-P2026C	C
				20	M3a	4X100	57	M12X1,50		0-P2026CS	B
				20	M5	4X100	57	M12X1,50		0-PN2026CD*	
				25	M5	4X100	57	M12X1,50		0-P2526CD	
				30	M5	4X100	57	M12X1,50		0-P3026CD	
				35	M5	4X100	57	M12X1,50		0-P3526CD	
				40	M5	4X100	57	M12X1,50		0-P4026CD	
45	M5	4X100	57	M12X1,50		0-P4526CD					
50	M5	4X100	57	M12X1,50		0-P5026CD					
Bora Type 1J Corrado Type 53I 2.9i VR6 Fox Type 5Z Golf III 2.0i GTI Type 1HX0 Golf III 2.9i VR6 Type 1HX Golf IV Type 1J New Beetle Type 9C New Beetle Cabrio Type 1Y Passat Type 3A2 / 35I Polo Cross IV Type 9N Polo Fox IV Type 9N Polo Fun IV Type 9N Polo V Type 6R Polo VI Type AW Polo R WRC Type 6R T-Cross Type C1 Vento Type 1HX0	1997 Aug/1987 2005 1991 1991 Aug/1997 1998 2003 Feb/1988 2001 2005 2005 June/2009 2017 2013 2019 Nov/1991	2002 Feb/1995 2011 1996 1996 Aug/2003 2010 2010 June/1996 2004 May/2009 May/2009 2017 > 2014 > Sept/1998	7 7 7 7 7 7 7 7 7 7 7 7 7 7 7 7 7	5	M1	5X100	57	M14X1,50	0-P0527S	A-Y	
				5	M2a	5X100	57	M14X1,50		0-P0527C	C-Y
				5	M3a	5X100	57	M14X1,50		0-P0527CS	B-Y
				10	M1	5x100	57			0-P10270ES	Z
				12	M1	5X100	57	M14X1,50		0-P1227S	
				12	M2a	5X100	57	M14X1,50		0-P1227C	C
				12	M3a	5X100	57	M14X1,50		0-P1227CS	B
				16	M1	5X100	57	M14X1,50		0-P1627S	
				16	M2a	5X100	57	M14X1,50		0-P1627C	C
				16	M3a	5X100	57	M14X1,50		0-P1627CS	B
				20	M1	5X100	57	M14X1,50		0-P2027S	
				20	M2a	5X100	57	M14X1,50		0-P2027C	C
				20	M3a	5X100	57	M14X1,50		0-P2027CS	B
				20	M5	5X100	57	M14X1,50		0-PN2027CD*	
				25	M1	5X100	57			0-PN2527S*	
				25	M5	5X100	57	M14X1,50		0-P2527CD	
				30	M5	5X100	57	M14X1,50		0-P3027CD	
35	M5	5X100	57	M14X1,50		0-P3527CD					
40	M5	5X100	57	M14X1,50		0-PN4027CD*					
50	M5	5X100	57	M14X1,50		0-PN5027CD*					
Amarok Type 2H/2HS2/S1B Amarok Type S6B/S7A/S7B Bus T5 Type 7H Bus T6 Type 7HC - 7J0 Crafter Bus Type SY Crafter Pritsche Type SZ Tuareg R5 Type 7L 2.5 TDI V5	2010 2016 2003 2015 2016 2016 Jan/2003	2015 > 2015 > > > > May/2010	14 14 14 14 14 14 14	5	M1	5X120	65	M14X1,50	0-PN0563S*	Y	
				16	M1	5X120	65	M14X1,50		0-P1663S	
				16	M3a	5X120	65	M14X1,50		0-P1663CS	B-H
				20	M1	5X120	65	M14X1,50		0-P2063S	
				20	M3a	5X120	65	M14X1,50		0-P2063CS	B-H
				20	M5	5X120	65	M14X1,50		0-PN2063CD*	
				25	M5	5X120	65	M14X1,50		0-PN2563CD*	
				30	M5	5X120	65	M14X1,50		0-PN3063CD*	
35	M5	5X120	65	M14X1,50		0-PN3563CD*					

*DIAMOND FINISH / Finitura diamantata • Available in one week / Disponibile in una settimana

VOLKSWAGEN



MODELLO / MODEL	ANNO / YEAR DA / START	A / END	NOTA CHIAVE KEY NOTE	SPESSORE THICKNESS (mm)	TIPO TYPE	INTERASSE C TO C	Ø	FILETTO THREAD	CODICE CODE #	NOTE NOTES
Arteon	2017	>		5	M1	5X112	57	M14X1,50	0-P0506S	A-Y
Beetle Type 5C1	2011	>		5	M2a	5X112	57	M14X1,50	0-P0506C	C-Y
Caddy/Caddy Life/Caddy	2003	2015		5	M3a	5X112	57	M14X1,50	0-P0506CS	B-Y
Alltrack Type 2K-2KN				12	M1	5X112	57	M14X1,50	0-P1206S	
Caddy/Caddy Life/Caddy	2015	>		12	M2a	5X112	57	M14X1,50	0-P1206C	C
Alltrack Type SAA-SAB				12	M3a	5X112	57	M14X1,50	0-P1206CS	B
Eos Type 1F	2006	2015		10	M1	5x100/5x112	57		0-P10060ES	Z
Golf V Type 1K	Nov/2003	Nov/2008		13	M1	5x112	57		0-P13060ES	Z
Golf V R32 Type 1K	Nov/2003	Nov/2008		16	M1	5X112	57	M14X1,50	0-P1606S	
Golf V Variant Type 1KM	Nov/2003	Nov/2008		16	M2a	5X112	57	M14X1,50	0-P1606C	C
Golf V Plus Type 1KP	Mar/2005	2008		16	M3a	5X112	57	M14X1,50	0-P1606CS	B
Golf VI Type 1K	Nov/2008	Oct/2012		16	M1	5X112	57	M14X1,50	0-P1606S	
Golf VII Type AU	Nov/2012	>		20	M1	5X112	57	M14X1,50	0-P2006S	
Golf VII GTI Type AU	2013	>		20	M2a	5X112	57	M14X1,50	0-P2006C	C
Golf VII R Type AU	2013	>		20	M3a	5X112	57	M14X1,50	0-P2006CS	B
Golf VIII inclus. GTI Type CD	Dec/2019	>		20	M5	5X112	57	M14X1,50	0-PN2006CD*	
Golf VIII GTE Type CD	Jan/2020	>		25	M5	5X112	57	M14X1,50	0-P2506CD	
ID.3 Type ID.3 - E1	nov-19	>		30	M5	5X112	57	M14X1,50	0-P3006CD	
ID.4 Type ID.4 - E2	Jan/2020	>		35	M5	5X112	57	M14X1,50	0-P3506CD	
Jetta Type 1KM	2004	>		40	M5	5X112	57	M14X1,50	0-P4006CD	
Maggiolino Type 5C1 - 5C7	2011	>		50	M5	5X112	57	M14X1,50	0-PN5006CD*	
Passat Type 3B	June/1996	2004		5	M1	5X130	71,5	M14X1,50	0-P0537S	H
Passat Type 3C/B6	2005	2010		5	M2a	5X130	71,5	M14X1,50	0-P0537CS	N-H
Passat Type 3C/B7	2010	2014		8	M1	5X130	71,5		0-PN0837S* NEW	H
Passat Type 3C/B8	2014	>		10	M1	5X130	71,5		0-PN1037S* NEW	H
Passat Type 3CC	June/2008	2012		12	M1	5X130	71,5	M14X1,50	0-P1237S	
Phaeton Type 3D	2002	2016		12	M2a	5X130	71,5	M14X1,50	0-P1237CS	N
Scirocco III Type 13	Sept/2008	2017		16	M1	5X130	71,5	M14X1,50	0-P1637S	
Sharan Type 7M	1995	2010		16	M3a	5X130	71,5	M14X1,50	0-P1637CS	N
Sharan Type N1	2011	>		20	M1	5X130	71,5	M14X1,50	0-P2037S	
T-ROC Type 5N - A1	2017	>		20	M3a	5X130	71,5	M14X1,50	0-P2037CS	N
T-ROC CabrioType A1	2019	>		20	M2a	5X130	71,5	M14X1,50	0-PN2037C*	
Tiguan Type 5N	2007	>		25	M1	5X130	71,5		0-PN2537S*	
Touran / Cross Type 1T	2003	2015		20	M5	5X130	71,5	M14X1,50	0-PN2092CD*	H
Touran / Cross Type 5T	2016	>		25	M5	5X130	71,5	M14X1,50	0-P2592CD	H
				30	M5	5X130	71,5	M14X1,50	0-P3092CD	H
				40	M5	5X130	71,5	M14X1,50	0-PN4092CD*	H
				80	M5	5x130	71,5	M14X1,50	0-PN8092CD*	
				120	M5	5X130	71,5	M14X1,50	0-PN12092CD*	
Crafter Type 2E C1 - C2 - KE - KE2	2006	2016		25	M5	6X130	84	M14X1,50	0-PNFSM625* NEW	H
				30	M5	6X130	84	M14X1,50	0-PNFSM630* NEW	H

VOLKSWAGEN (Off-road)

Taro incl. 4X4 Type 7AX1	Apr/1989	Mar/1997		30	M4	6X139,7	108	M12X1,50	0-PFSM130	M-Y
				40	M4	6X139,7	108	M12X1,50	0-PNFSM140*	Y
				50	M4	6X139,7	108	M12X1,50	0-PNFSM150*	Y
				60	M4	6X139,7	108	M12X1,50	0-PNFSM160* NEW	Y

VOLVO

MODELLO / MODEL	ANNO / YEAR DA / START A / END	NOTA CHIAVE KEY NOTE	SPESSORE THICKNESS (mm)	TIPO TYPE	INTERASSE C TO C	Ø	FILETTO THREAD	CODICE CODE #	NOTE NOTES
S40 I Type V V40 I Type V	1995 1995		16	M1	4X114,3	67		0-P1611S	
			16	M2b	4X114,3	67	M12X1,50	0-P1611C	L
			20	M1	4X114,3	67		0-P2011S	
			20	M2b	4X114,3	67	M12X1,50	0-P2011C	L
			20	M4	4X114,3	67	M12X1,50	0-P2011CD	M
C30 Type M C70 Type M S40 II Type M V40 II Type M V50 Type MW	Dec/2006 May/2006 Jan/2004 2012 Apr/2004	2012 2013 Aug/2012 2019 2012	5	M1	5X108	63,3		0-P0561S	A-Y
			16	M1	5X108	63,3		0-P1661S	
			16	M2b	5X108	63,3	M12X1,50	0-P1661C	R
			20	M1	5X108	63,3		0-P2061S	
			20	M2b	5X108	63,3	M12X1,50	0-P2061C	R
			20	M4	5X108	63,3	M12X1,50	0-P2061CD	M
			25	M4	5X108	63,3	M12X1,50	0-P2561CD	M
850 Type L / LS / LW S70 I Type L C70 Type N Cabrio / Coupé V70 I Type L	1992 Jan/1997 Mar/1997 Jan/1997	1992 Jan/1997 Mar/1997 Jan/1997	16	M1	5X108	65		0-P1631S	
			16	M2a	5X108	65	M12X1,75	0-P1631C	
			20	M1	5X108	65		0-P2031S	
			20	M2a	5X108	65	M12X1,75	0-P2031C	
S60 I Type R - H S80 I Type T V70 II Type S XC70 I Type S	2000 1998 Mar/2000 2000	Apr/2010 Apr/2006 Sept/2007 Sept/2007	16	M1	5X108	65		0-P1631S	
			16	M2a	5X108	65	M14X1,50	0-P1646C	
			20	M1	5X108	65		0-P2031S	
			20	M2a	5X108	65	M14X1,50	0-P2046C	
			30	M5	5X108	65	M14X1,50	0-PN3046CD*	
			35	M5	5X108	65	M14X1,50	0-PN3546CD*	
XC90 I Type C XC90 II	2002 Sept/2014	Aug/2014 May/2015	16	M2a	5X108	67	M14X1,50	0-P16129C	
			20	M2a	5X108	67	M14X1,50	0-P20129C	
S60 II Type F S60 III Type Z S80 II Type A S90 II Type P V60 I Type F V60 II Type F-F2ND V60 III Type 225 V70 III Type B - 2D - N2D - N2E V90 II Type P XC40 Type 536 XC60 I Type D XC60 II Type U XC70 II Type B XC90 III Type L	Apr/2010 2019 May/2006 2016 Sept/2010 2013 2018 2007 2016 2018 Nov/2008 2017 Oct/2007 2015	Apr/2010 2019 May/2006 2016 Sept/2010 2013 2018 2007 2016 2018 Nov/2008 2017 Oct/2007 2015	5	M1	5X108	63,3		0-P0561S	A-Y
			16	M1	5X108	63,3		0-P1661S	
			16	M2a	5X108	63,3	M14X1,50	0-P1677C	
			20	M1	5X108	63,3		0-P2061S	
			20	M2a	5X108	63,3	M14X1,50	0-P2077C	
			20	M5	5X108	63,3	M14X1,50	0-PN2077CD*	
			30	M5	5X108	63,3	M14X1,50	0-PN3077CD*	
			30	M5	5X108	63,3	M14X1,50	0-PN3077CD*	
240 - 265 Type P244 - 245	1974	1993	20	M4	5X108	65	1/2" UNF	0-PN20130CD*	
			30	M4	5X108	65	1/2" UNF	0-PN30130CD*	
340-360 Type 343-500 340-360 Type 340-500 440-480 Type E-EX-K-KX-L-LX	1976 1983 1986	1991 1990 1997	30	M4	4X100	52	M12X1,25	0-PN3035CD*	
			40	M4	4X100	52	M12X1,25	0-PN4035CD*	
			50	M4	4X100	52	M12X1,25	0-PN5035CD*	
704-765 Type 704-744-764-705-765 740-760 Type 754-765 940-960 Type 945-965/9 S90-V90 Type 9	1982 1985 1991 1994	1992 1992 1998 1998	25	M4	5X108	65	M12X1,50	0-PN2538CD*	
			30	M4	5X108	65	M12X1,50	0-PN3038CD*	
			40	M4	5X108	65	M12X1,50	0-PN4038CD*	
			50	M4	5X108	65	M12X1,50	0-PN5038CD*	
S40 - V40 Type V	1995	2004	30	M4	4X114,3	67	M12X1,50	0-PN3011CD	
			35	M4	4X114,3	67	M12X1,50	0-PN3511CD	
			40	M4	4X114,3	67	M12X1,50	0-PN4011CD	

*DIAMOND FINISH / Finitura diamantata • Available in one week / Disponibile in una settimana

BULLONI BOLTS
& DADI & NUTS



BULLONI CONICI / CONE SEAT LUG BOLTS

MODELLO / MODEL

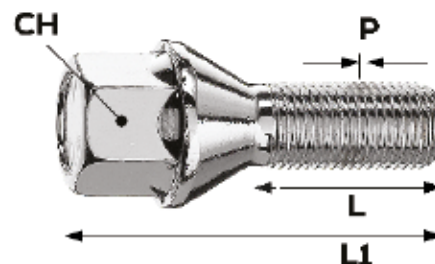

Passo (P) Screw pitch (P)	Lunghezza filettatura (L) Thread length (L) (mm)	Lunghezza totale (L1) Total length (L1) (mm)	Chiave (CH) Socket size (CH)	Peso Weight (gr)	Sede conica Cone seat	Classe acciaio Steel class	Codice Part N.
M12x1,25	34	59	19	80	60°	10.9	O-BC01
M12x1,25	42	67	19	83	60°	10.9	O-BC02
M12x1,25	46	71	19	86	60°	10.9	O-BC03
M12x1,25	50	77	19	87	60°	10.9	O-BC04
M12x1,25	28	52	17	66	60°	10.9	O-BC06
M12x1,25	36	60	17	74	60°	10.9	O-BC07
M12x1,25	39	64	17	79	60°	10.9	O-BC08
M12x1,25	45	70	17	84	60°	10.9	O-BC09
M12x1,25	50	75	17	86	60°	10.9	O-BC10
M12x1,25	60	85	17	87	60°	10.9	O-BC37
M12x1,50	28	53,5	17	70	60°	10.9	O-BC11
M12x1,50	32	57,5	17	72	60°	10.9	O-BC12
M12x1,50	39	64	17	79	60°	10.9	O-BC13
M12x1,50	45	70,5	17	78	60°	10.9	O-BC14
M12x1,50	50	75	17	84	60°	10.9	O-BC15
M12x1,50	32	59	19	80	60°	10.9	O-BC16
M12x1,50	40	66	19	90	60°	10.9	O-BC38
M12x1,50	45	69	19	90	60°	10.9	O-BC17
M12x1,50	50	74	19	90	60°	10.9	O-BC18
M14x1,25	35	58,5	17	81	60°	10.9	O-BC20
M14x1,25	40	63,5	17	89	60°	10.9	O-BC21
M14x1,25	43	66,5	17	91	60°	10.9	O-BC22
M14x1,25	47	73,5	17	99	60°	10.9	O-BC23
M14x1,50	33	56	17	78	60°	10.9	O-BC24
M14x1,50	40	63,5	17	81	60°	10.9	O-BC25
M14x1,50	45	69	17	95	60°	10.9	O-BC26
M14x1,50	50	74	17	99	60°	10.9	O-BC27
M14x1,50	45	69	19	98	60°	10.9	O-BC28
M14x1,50	50	73	19	102	60°	10.9	O-BC29
M12x1,75	45	69	19	94	60°	10.9	O-BC30
M12x1,75	50	73	19	98	60°	10.9	O-BC31

BULLONI CONICI NERI / BLACK CONE SEAT LUG BOLTS

MODELLO / MODEL

NEW



Passo (P) Screw pitch (P)	Lunghezza filettatura (L) Thread length (L) (mm)	Lunghezza totale (L1) Total length (L1) (mm)	Chiave (CH) Socket size (CH)	Peso Weight (gr)	Sede conica Cone seat	Classe acciaio Steel class	Codice Part N.
M12X1,25	32	57,5	17	72	60°	10.9	O-BC12B
M12X1,25	40	64	17	79	60°	10.9	O-BC13B
M12X1,25	45	70,5	17	78	60°	10.9	O-BC14B
M12X1,25	50	75	17	84	60°	10.9	O-BC15B
M14X1,25	35	58,5	17	81	60°	10.9	O-BC20B
M14X1,25	40	63,5	17	89	60°	10.9	O-BC21B
M14X1,25	43	66,5	17	91	60°	10.9	O-BC22B
M14X1,25	47	73,5	17	99	60°	10.9	O-BC23B
M14X1,50	40	63,5	17	81	60°	10.9	O-BC25B
M14X1,50	45	69	17	95	60°	10.9	O-BC26B
M14X1,50	50	74	17	99	60°	10.9	O-BC27B

BULLONI CONICI / BALL SEAT LUG BOLTS

MODELLO / MODEL

Uguale al bullone originale Ferrari-Maserati
Equal to OEM Ferrari-Maserati

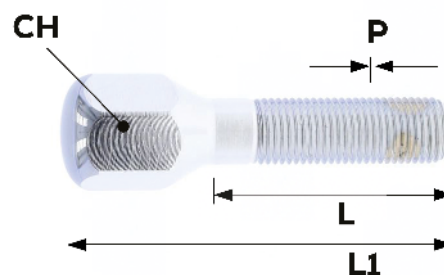

Passo (P) Screw pitch (P)	Lunghezza filettatura (L) Thread length (L) (mm)	Lunghezza totale (L1) Total length (L1) (mm)	Chiave (CH) Socket size (CH)	Peso Weight (gr)	Raggiatura Radius	Classe acciaio Steel class	Codice Part N.
M14x1,50	48	60	22	140	60°	10.9	O-BC32
M14x1,50	52	65	22	145	60°	10.9	O-BC33
M14x1,50	66	96	22	160	60°	10.9	O-BC34
M14x1,50	70	100	22	165	60°	10.9	O-BC35
M14x1,50	75	105	22	170	60°	10.9	O-BC36
M14X1,25	25	40	17	50	60°	10.9	O-BC40TBEIS

BULLONI SFERICI / BALL SEAT LUG BOLTS

MODELLO / MODEL

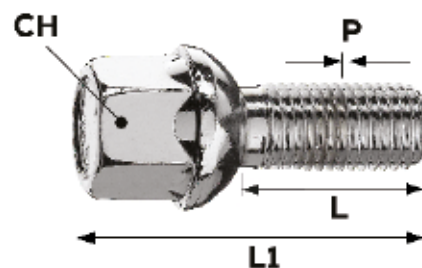

Passo (P) Screw pitch (P)	Lunghezza filettatura (L) Thread length (L) (mm)	Lunghezza totale (L1) Total length (L1) (mm)	Chiave (CH) Socket size (CH)	Peso Weight (gr)	Raggiatura Radius	Classe acciaio Steel class	Codice Part N.
M12x1,50	35	57,5	17	70	R12	10,9	O-BS01
M12x1,50	40	60,5	17	70	R12	10,9	O-BS03
M12x1,50	45	65	17	70	R12	10,9	O-BS02
M12x1,50	50	72,5	17	80	R12	10,9	O-BS04
M12x1,50	60	81	17	80	R12	10,9	O-BS05
M14x1,50	33	53	17	70	R13	10,9	O-BS07
M14x1,50	40	61	17	80	R13	10,9	O-BS08
M14x1,50	45	66	17	80	R13	10,9	O-BS09
M14x1,50	50	72	17	90	R13	10,9	O-BS10
M14x1,50	60	81	17	100	R13	10,9	O-BS11
M14x1,50	65	85	17	100	R13	10,9	O-BS12
M14x1,50	35	54,5	17	70	R14	10,9	O-BS19
M14x1,50	40	59	17	80	R14	10,9	O-BS20
M14x1,50	43	62	17	90	R14	10,9	O-BS21
M14x1,50	45	64	17	90	R14	10,9	O-BS22
M14x1,50	50	70	17	100	R14	10,9	O-BS23
M14x1,50	55	75	17	100	R14	10,9	O-BS24
M14x1,50	60	80	17	110	R14	10,9	O-BS25
M14x1,50	65	85	17	110	R14	10,9	O-BS26

MODELLO / MODEL

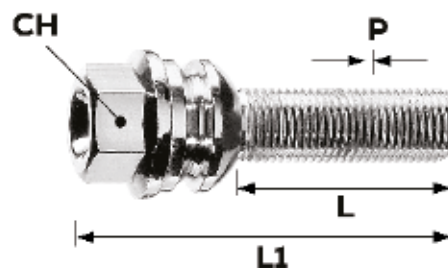

Uguale al bullone originale Porsche-Gruppo VAG
Equal to OEM Porsche and VAG group

Passo (P) Screw pitch (P)	Lunghezza filettatura (L) Thread length (L) (mm)	Lunghezza totale (L1) Total length (L1) (mm)	Chiave (CH) Socket size (CH)	Peso Weight (gr)	Raggiatura Radius	Classe acciaio Steel class	Codice Part N.
M14x1,50	37	59,5	19	120	R14	10,9	O-BS13
M14x1,50	42	71,5	19	120	R14	10,9	O-BS14
M14x1,50	45	74,5	19	130	R14	10,9	O-BS15
M14x1,50	48	77,5	19	110	R14	10,9	O-BS16
M14x1,50	53	82,5	19	140	R14	10,9	O-BS17
M14x1,50	58	87,5	19	140	R14	10,9	O-BS18

BULLONI SFERICI NERI / BLACK BALL SEAT LUG BOLTS

MODELLO / MODEL

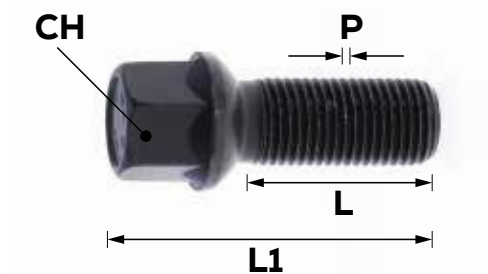

Passo (P) Screw pitch (P)	Lunghezza filettatura (L) Thread length (L) (mm)	Lunghezza totale (L1) Total length (L1) (mm)	Chiave (CH) Socket size (CH)	Peso Weight (gr)	Raggiatura Radius	Classe acciaio Steel class	Codice Part N.
M14x1,50	35	54,5	17	70	14	10.9	0-BS19B
M14x1,50	40	59	17	80	14	10.9	0-BS20B
M14x1,50	43	62	17	90	14	10.9	0-BS21B
M14x1,50	45	64	17	90	14	10.9	0-BS22B
M14x1,50	50	70	17	100	14	10.9	0-BS23B
M14x1,50	55	75	17	100	14	10.9	0-BS24B
M14x1,50	60	80	17	110	14	10.9	0-BS25B
M14x1,50	65	85	17	110	14	10.9	0-BS26B

MODELLO / MODEL

NEW

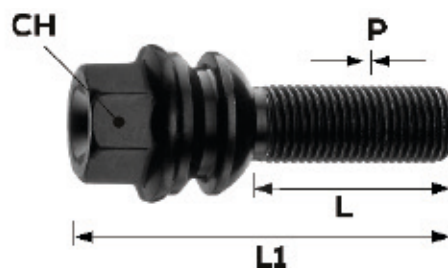

Uguale al bullone originale Porsche-Gruppo VAG
Equal to OEM Porsche and VAG group

Passo (P) Screw pitch (P)	Lunghezza filettatura (L) Thread length (L) (mm)	Lunghezza totale (L1) Total length (L1) (mm)	Chiave (CH) Socket size (CH)	Peso Weight (gr)	Raggiatura Radius	Classe acciaio Steel class	Codice Part N.
M14X1,50	33	53	17	70	R13	10.9	0-BS07B
M14X1,50	40	61	17	80	R13	10.9	0-BS08B
M14X1,50	45	66	17	80	R13	10.9	0-BS09B
M14X1,50	50	72	17	90	R13	10.9	0-BS10B
M14X1,50	37	59,5	19	120	R14	10.9	0-BS13B
M14X1,50	42	71,5	19	120	R14	10.9	0-BS14B
M14X1,50	45	74,5	19	130	R14	10.9	0-BS15B
M14X1,50	48	77,5	19	110	R14	10.9	0-BS16B
M14X1,50	53	82,5	19	140	R14	10.9	0-BS17B
M14X1,50	58	87,5	19	140	R14	10.9	0-BS18B

BULLONI SFERICI NERI / BLACK BALL SEAT LUG BOLTS

MODELLO / MODEL

NEW

Uguale al bullone per Mercedes GLE Coupé (W167) e GLS (X167)

Equal to OEM Mercedes GLE Coupé (W167) e GLS (X167) bolts



Passo (P) Screw pitch (P)	Lunghezza filettatura (L) Thread length (L) (mm)	Lunghezza totale (L1) Total length (L1) (mm)	Chiave (CH) Socket size (CH)	Peso Weight (gr)	Raggiatura Radius	Classe acciaio Steel class	Codice Part N.
M15x1,25	50	72	17	100	R14	10.9	O-BS50B
M15x1,25	57	80	17	100	R14	10.9	O-BS57B
M15x1,25	60	82	17	100	R14	10.9	O-BS60B

BULLONI PIATTI / FLAT SEAT LUG BOLTS

MODELLO / MODEL

Comprensivo di rondella imperdibile

Unmovable washer included



Passo (P) Screw pitch (P)	Lunghezza filettatura (L) Thread length (L) (mm)	Lunghezza totale (L1) Total length (L1) (mm)	Chiave (CH) Socket size (CH)	Peso Weight (gr)	classe acciaio steel class	Codice Part N.
M12x1,25	40	60	17	90	10.9	O-FB02
M12x1,25	50	72	17	100	10.9	O-FB03
M12x1,25	55	77	17	105	10.9	O-FB04
M12x1,25	50	80	17	110	10.9	O-FB07

COLONNETTA A PIANTAGGIO / SPLINE WHEEL STUDS

MODELLO / MODEL

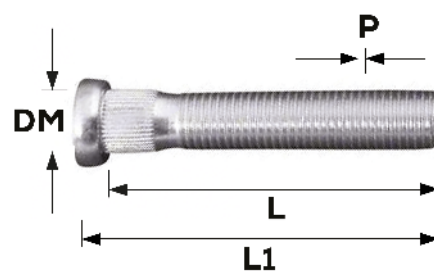

Passo (P) Screw pitch (P)	Lunghezza filettatura (L) Thread length (L) (mm)	Lunghezza totale (L1) Total length (L1) (mm)	Diametro zigrino (DM) Knurl diameter (mm)	Peso Weight (gr)	classe acciaio steel class	Codice Part N.
M12x1,50	27	42	13,00	40	10.9	0-SS15
M12x1,50	40	57	13,00	50	10.9	0-SS05
M12x1,50	51	67	13,00	60	10.9	0-SS06
M12x1,50	51	67	12,20	50	10.9	0-SS01
M12x1,50	51	67	14,20	60	10.9	0-SS07
M12x1,25	26	42	13,00	60	10.9	0-SS16
M12x1,25	42	57	13,00	50	10.9	0-SS10
M12x1,25	51	67	13,00	60	10.9	0-SS11
M12x1,25	51	67	14,30	60	10.9	0-SS14
M14x1,50	25	42	15,00	50	10.9	0-SS17
M14x1,50	44	60	15,00	70	10.9	0-SS12
M14x1,50	54	70	15,00	80	10.9	0-SS13
M14x1,50		50	15,00		10.9	0-SS19
M16x1,50	36	53	17,00	80	10.9	0-SS09
1/2" UNFx20"	41	55	13,00	50	10.9	0-SS02

PRIGIONIERI / HUB STUDS

MODELLO / MODEL

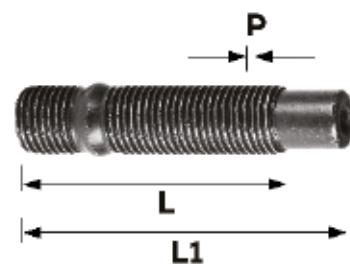

Passo (P) Screw pitch (P)	Lunghezza filettatura (L) Thread length (L) (mm)	Lunghezza totale (L1) Total length (L1) (mm)	Lunghezza non filettata (mm) Length with thread (mm)	Peso Weight (gr)	classe acciaio steel class	Codice Part N.
M12x1,25	82	49	15	60	10.9	0-HS02
M12x1,50	82	49	15	60	10.9	0-HS03
M14x1,50	82	49	15	80	10.9	0-HS04

DADI CONICI APERTI / CONE SEAT OPEN NUTS

MODELLO / MODEL

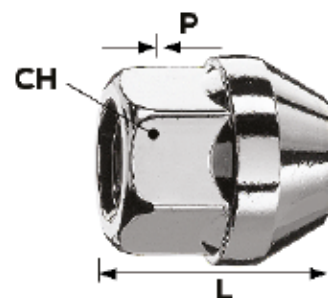

Passo (P) Screw pitch (P)	Tipo Type	Lunghezza totale (L) Total length (L) (mm)	Chiave (CH) Socket size (CH)	Peso Weight (gr)	Sede conica Cone seat	Classe acciaio Steel class	Codice Part N.
1/2" UNF x20"	aperto/OPEN	17	19	20	60°	8.8	O-N01
1/2" UNF x20"	aperto/OPEN	24	19	60	60°	8.8	O-N02
M12x1,25	aperto/OPEN	15	19	20	60°	8.8	O-N13
M12x1,25	aperto/OPEN	17	19	30	60°	8.8	O-N03
M12x1,25	aperto/OPEN	24	19	40	60°	8.8	O-N04
M12x1,25	aperto/OPEN	23	17	30	60°	8.8	O-N11
M12x1,50	aperto/OPEN	15	19	20	60°	8.8	O-N12
M12x1,50	aperto/OPEN	17	19	20	60°	8.8	O-N06
M12x1,50	aperto/OPEN	24	19	40	60°	8.8	O-N07
M12x1,50	aperto/OPEN	24	17	30	60°	8.8	O-N05
M14x1,50	aperto/OPEN	17	19	20	60°	8.8	O-N10
M14x1,50	aperto/OPEN	24	19	40	60°	8.8	O-N08
M16x1,50	aperto/OPEN	20	22	40	60°	8.8	O-N09

DADI SFERICI / BALL SEAT NUTS

MODELLO / MODEL

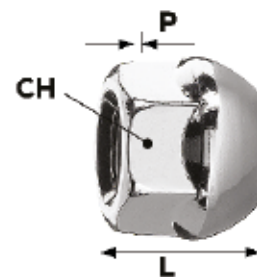

Passo (P) Screw pitch (P)	Tipo Type	Lunghezza totale (L) Total length (L) (mm)	Chiave (CH) Socket size (CH)	Peso Weight (gr)	Raggiatura Radius	Classe acciaio Steel class	Codice Part N.
M12x1,50	aperto/OPEN	19	19	30	R12	8.8	O-N24
M14x1,50	aperto/OPEN	20	19	30	R14	8.8	O-N15

DADI CONICI CHIUSI / CONE SEAT CLOSED NUTS

MODELLO / MODEL

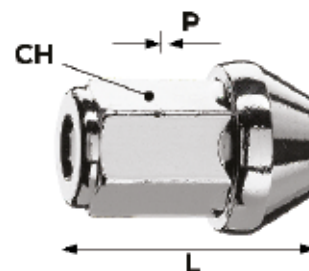

Passo (P) Screw pitch (P)	Tipo Type	Lunghezza totale (L) Total length (L) (mm)	Chiave (CH) Socket size (CH)	Peso Weight (gr)	Sede conica Cone seat	Classe acciaio Steel class	Codice Part N.
M12x1,25	chiuso/ CLOSED	32	19	60	60°	8.8	O-N16
M12x1,25	chiuso/ CLOSED	34	17	50	60°	8.8	O-N20
M12x1,50	chiuso/ CLOSED	30	19	50	60°	8.8	O-N22
M12x1,50	chiuso/ CLOSED	32	19	60	60°	8.8	O-N17
M12x1,50	chiuso/ CLOSED	34	17	50	60°	8.8	O-N19
M14x1,50	chiuso/ CLOSED	30	19	40	60°	8.8	O-N18
M14x1,50	chiuso/ CLOSED	34	19	50	60°	8.8	O-N21

DADI PIATTI / FLAT SEAT NUTS

MODELLO / MODEL

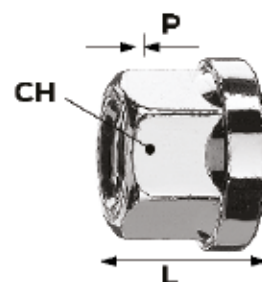

Passo (P) Screw pitch (P)	Tipo Type	Lunghezza totale (L) Total length (L) (mm)	Chiave (CH) Socket size (CH)	Peso Weight (gr)	Classe acciaio Steel class	Codice Part N.
M12x1,25	piatto /FLAT	17	19	30	8.8	O-N23

BRUGOLE / ALLEN KEYS

MODELLO / MODEL



Passo (P) Screw pitch (P)	Lunghezza filettatura (L) Thread length (L) (mm)	Lunghezza totale (L1) Total length (L1) (mm)	Peso Weight (gr)	Classe acciaio Steel class	Codice Part N.
M12X1,25	35	47	40	12.9	0-SBR1212535
M12X1,50	35	47	40	12.9	0-SBR1215035
M14X1,25	35	50	50	12.9	0-SBR1412535
M14X1,50	35	50	50	12.9	0-SBR1415035

BOCCOLE / BUSHINGS

MODELLO / MODEL



Passo (P) Screw pitch (P)	Lunghezza totale (L1) Total length (L1) (mm)	Peso Weight (gr)	Classe acciaio Steel class	Codice Part N.
M12X1,25	18	30	6.8	0-SB12125
M12X1,50	18	30	6.8	0-SB12150
M14X1,25	18	30	6.8	0-SB14125
M14X1,50	18	30	6.8	0-SB14150

**CONDIZIONI GENERALI
GENERALI CONDITION
DI VENDITA OF SALE**

Articolo 1 - NORMATIVA CONTRATTUALE

1.1. Le presenti condizioni generali, salvo eventuali deroghe specificatamente concordate per iscritto, disciplinano tutti gli attuali e futuri contratti di vendita fra le parti. Eventuali condizioni generali dell'acquirente non troveranno applicazione ai rapporti futuri fra le parti se non espressamente accettate per iscritto; in tal caso però, salvo deroga scritta, non escluderanno l'efficacia delle presenti condizioni generali, con cui dovranno venir coordinate.

1.2. Il riferimento ad eventuali termini commerciali (Franco Fabbrica, FOB, CIF, ecc.) si intenderà fatto agli Incoterms della Camera di Commercio Internazionale, nel testo in vigore al momento della conclusione del contratto.

1.3. Tutti i contratti di vendita fra le parti, nonché le presenti condizioni generali, saranno disciplinati dalla legge italiana, ed in particolare dalla legge uniforme sulla vendita internazionale di cose mobili materiali, ratificata con legge 21 giugno 1971, nonché dalla legge uniforme sulla formazione dei contratti di vendita internazionale di cose mobili materiali, ratificata in pari data; le eventuali deroghe o richiami delle parti a specifici articoli della legge italiana non implicano un'esclusione dell'applicazione delle succitate leggi uniformi per quanto compatibili con la disciplina contrattuale.

1.4. L'adesione alle presenti condizioni generali, nonché tutti i contratti ed i comportamenti successivi delle parti dalle stesse regolati, salvo diversa espressa pattuizione scritta non implicano il conferimento all'acquirente di esclusiva alcuna né l'instaurazione di rapporti di concessione, commissione o mandato, con o senza rappresentanza, come non conferiscono all'acquirente stesso il diritto ad utilizzare in qualunque forma i marchi od i segni distintivi del venditore.

Articolo 2 - FORMAZIONE ED OGGETTO DEL CONTRATTO

2.1. Le offerte fatte da agenti, rappresentanti ed ausiliari di commercio di Athena S.p.A. non sono per essa impegnative fino a quando non siano confermate da Athena stessa.

2.2. L'invio delle presenti condizioni generali non implica di per sé accettazione di eventuali offerte, nell'ambito di trattative in corso; esse tuttavia sostituiscono ed annullano quelle in precedenza proposte da una delle parti.

2.3. L'invio da parte di Athena di listini prezzi o di materiale descrittivo dei prodotti non recante espressamente la dizione "offerta" od altra equivalente, non può venir considerato proposta. Le dizioni "senza impegno", "salvo disponibilità" od altre analoghe apposte da Athena ad un'offerta non vincolano la stessa ai termini dell'offerta anche in caso di accettazione dell'offerta stessa ad opera del compratore, salvo successiva conferma scritta od esecuzione conforme da parte di Athena. L'offerta si considera ferma ed è irrevocabile soltanto se viene dallo stesso qualificata tale per iscritto ed è in essa specificato un termine di validità della clausola.

2.4. L'accettazione di un contratto da parte del compratore, comunque effettuata, comporta la sua adesione alle presenti condizioni generali. Nel caso in cui Athena abbia emesso, anche successivamente alla conclusione del contratto, una conferma d'ordine, si presume che i termini del contratto corrispondano a quelli della conferma d'ordine, salvo che il compratore non ne reivi immediatamente per iscritto le differenze.

2.5. L'accettazione senza espressa riserva da parte del compratore di prodotti non conformi per tipo o quantità inviati a condizioni diverse da quelle contenute nella richiesta del compratore implica accettazione, da parte di quest'ultimo, della fornitura e delle condizioni proposte da Athena. Le suddette riserve (anche se formulate sotto forma di precisazioni o rettifiche delle condizioni di fornitura) non avranno efficacia se non saranno formulate dal compratore per iscritto, immediatamente dopo il ricevimento della merce.

2.6. Tutte le registrazioni o trascrizioni richieste dagli Stati dei contraenti o nel Paese di destinazione dei beni per dare piena efficacia ai contratti disciplinati dalle presenti condizioni generali, o ad una loro clausola, dovranno essere effettuate dall'acquirente a proprie cure e spese.

2.7. Con l'adesione alle presenti condizioni generali di vendita, il compratore si impegna a non rivendere i prodotti contrattuali ad operatori professionali operanti mediante piattaforme on line (cd. e- marketplace).

Articolo 3 - CAMPIONI, DISEGNI E DOCUMENTI TECNICI

3.1. I pesi, le dimensioni, le capacità, i prezzi, i rendimenti, i colori e gli altri dati figuranti nei cataloghi, prospetti, circolari, annunci pubblicitari, illustrazioni, listini prezzi, od altri documenti illustrativi di Athena, così come le caratteristiche dei campioni e modelli da quest'ultima inviati al compratore, hanno carattere di indicazioni approssimative. Questi dati non hanno valore impegnativo se non nella misura in cui siano stati espressamente menzionati come tali nell'offerta o nell'accettazione scritta di Athena.

3.2. Nel caso in cui l'offerta o l'accettazione del compratore facciano riferimento ad un campione offerto da Athena, si intende che questo, salvo diversa espressa pattuizione scritta, nella sua fornitura è vincolato alle caratteristiche del campione nei soli limiti indicati al punto 3.1.

3.3. Nel caso in cui Athena riferisca la sua fornitura ad un campione fornito dal compratore, Athena stessa sarà responsabile – salva diversa pattuizione scritta – della conformità della sua prestazione (nei limiti di cui sopra al punto 3.1.) alle sole caratteristiche apparenti del campione.

3.4. Qualsiasi disegno o documento tecnico che permetta la fabbricazione o il montaggio dei prodotti venduti o di loro parti e sia rimesso al compratore, tanto prima che dopo la stipulazione del contratto, rimane di esclusiva proprietà di Athena. I suddetti disegni o documenti non possono essere utilizzati dal compratore o copiati, riprodotti, trasmessi o comunicati a terzi senza il consenso scritto da parte di Athena.

Articolo 4 - GARANZIA

4.1. Fuori dall'ambito di applicazione degli articoli precedenti, e fatto salvo quanto pattuito per iscritto di volta in volta fra le parti, Athena garantisce la conformità dei prodotti forniti a quanto espressamente concordato. La garanzia per vizi è limitata ai soli difetti dei prodotti conseguenti a difetti di progettazione, di materiale o di costruzione riconducibili ad Athena, e non si applica nel caso in cui il compratore non provi di aver effettuato un corretto uso, manutenzione e conservazione dei prodotti e di non averli modificati o riparati senza il consenso da parte di Athena.

4.2. La garanzia ha una durata limitata a 12 mesi, decorrenti dalla data della consegna, ed è subordinata alla regolare denuncia effettuata dal compratore ai sensi dell'articolo seguente, nonché all'espressa richiesta scritta ad Athena di effettuare un intervento in garanzia. In forza della suddetta richiesta Athena è tenuta (a sua scelta), entro un termine ragionevole avuto riguardo all'entità della contestazione, alternativamente:

a) a fornire gratuitamente Franco Fabbrica al compratore prodotti dello stesso genere e quantità di quelli risultati difettosi o non conformi a quanto pattuito; Athena può in tal caso esigere, a spese del compratore, la resa dei prodotti difettosi, che diventano di sua proprietà;

b) a riparare a proprie spese il prodotto difettoso o modificare quello non conforme al pattuito, effettuando le suddette operazioni in loco o presso i propri stabilimenti; in tali casi tutti i costi relativi al trasporto dei prodotti dovranno essere sopportati dal compratore;

c) a risarcire al compratore i danni, accreditandogli una somma pari al costo della riparazione o modificazione del prodotto presso i propri stabilimenti;

d) a dichiarare per iscritto la risoluzione del contratto, offrendo la restituzione del prezzo contro restituzione dei prodotti forniti. Salvo dolo o colpa grave da parte di Athena l'eventuale risarcimento danno al compratore non potrà comunque superare il prezzo di fattura dei prodotti contestati.

4.3. Tutti i prodotti "Racing" destinati ad un uso agonistico-sportivo sono privi di ogni garanzia espressa od implicita ed Athena declina ogni responsabilità.

4.4. La garanzia di cui al presente articolo è assorbente e sostitutiva delle garanzie legali per vizi e conformità ed esclude ogni altra possibile responsabilità di Athena comunque originata dai prodotti forniti; in particolare il compratore non potrà avanzare altre richieste di risarcimento del danno, di riduzione del prezzo o di risoluzione del contratto. Decorsa la durata della garanzia nessuna pretesa potrà esser fatta valere nei confronti di Athena.

Articolo 5 - RECLAMI E RESI

5.1. Ferme restando, in quanto applicabili, le disposizioni della legge 21 giugno 1971, di cui all'art. 1:

a) i reclami relativi a quantità, peso, tara totale, colore, oppure a vizi e difetti di qualità o non conformità che il compratore potrebbe rilevare non appena in possesso della merce, debbono essere effettuati dal compratore entro un breve termine dal momento in cui i prodotti sono pervenuti sul luogo di destinazione e comunque, a pena di decadenza, non oltre 15 giorni dal suddetto momento;

b) i vizi, difetti o non conformità occulti (cioè quelli non individuabili in base alla verifica imposta dalla legge e dal punto precedente al compratore) debbono essere denunciati entro un breve termine dalla scoperta e comunque, a pena di decadenza, non oltre 12 mesi dalla data della consegna.

5.2. I reclami devono essere effettuati mediante lettera raccomandata indirizzata ad Athena e devono indicare dettagliatamente i vizi o le non conformità contestate. Essi devono altresì contenere un preventivo dei costi di riparazione o modificazione dei prodotti in loco, ove possibile. In mancanza dei suddetti requisiti, ai reclami non potrà ricollegarsi efficacia alcuna.

5.3. Qualora il reclamo risulti infondato, il compratore sarà tenuto a risarcire ad Athena tutte le spese da questa sostenute per l'accertamento (viaggi, perizie, ecc.); uguale obbligo avrà il compratore se il reclamo risulti solo parzialmente fondato, per una percentuale non superiore al 30 per cento rispetto alle contestazioni originariamente effettuate.

5.4. Per resi merce dovuti a Vs. ordinazioni errate verrà applicata sulla nota di accredito una trattenuta del 15% sul valore della merce resa con un minimo di 20€.

Articolo 6 - NORME TECNICHE E RESPONSABILITÀ DEL PRODUTTORE

6.1. Premesso che per ciò che concerne le caratteristiche dei prodotti Athena si attiene alla legislazione e alle norme tecniche in vigore in Italia, il compratore si assume per intero il rischio di un'eventuale difformità tra le

norme italiane e quelle del Paese di destinazione dei prodotti, tenendone Athena indenne.

6.2. Athena è responsabile per danni a persone o cose, originati dai prodotti venduti, solo in caso di sua provata grave negligenza nella fabbricazione dei prodotti stessi; in nessun caso potrà essere ritenuto responsabile per danni indiretti o consequenziali, perdite di produzione o mancati profitti.

6.3. Fatto salvo quanto sopra previsto, il compratore manleverà Athena in tutte le azioni di terzi fondate su responsabilità originate dai prodotti vendutigli e risarcirà i danni derivanti dalle pretese in questione; Athena potrà coinvolgere il compratore – che dal canto suo dovrà prendere tutte le iniziative necessarie per intervenire – nel relativo giudizio intentato dai terzi.

Articolo 7 - CONSEGNA

7.1. Salvo diversa pattuizione scritta, la vendita si intende effettuata Franco Fabbrica: ciò anche ove sia pattuito che la spedizione (o parte di essa) venga curata da Athena, nel qual caso quest'ultimo agirà come mandatario del compratore, essendo inteso che il trasporto verrà effettuato a spese e rischio di quest'ultimo.

7.2. In caso di ritardata consegna, l'acquirente potrà annullare la parte dell'ordine non consegnata solo dopo aver comunicato ad Athena, mediante raccomandata con ricevuta di ritorno, tale sua intenzione e dopo avergli accordato 15 giorni feriali a partire dal ricevimento di tale comunicazione, entro i quali Athena potrà consegnare tutti i prodotti specificati nel sollecito e non già consegnati. E' comunque esclusa qualsiasi responsabilità per danni derivanti da ritardo o mancata consegna, totale o parziale.

7.3. Se non diversamente pattuito, la consegna Franco Fabbrica dei prodotti avviene mediante invio di comunicazione scritta (anche via telex) al compratore che i prodotti sono a sua disposizione; il compratore avrà 3 giorni di tempo dall'invio di tale comunicazione per provvedere al ritiro.

7.4. Ove il compratore non provveda al ritiro dei prodotti nei termini previsti dal paragrafo precedente, dovrà rimborsare ad Athena le spese di magazzino, forfaitariamente fissate in misura pari al 10% dell'importo della fattura relativa ai prodotti stessi per ogni settimana di ritardo; decorsi 30 giorni Athena potrà inoltre vendere con qualsiasi mezzo i prodotti per conto del compratore, trattenendo dal ricavato l'intero prezzo dovuto (quali che siano i termini di pagamento pattuiti) nonché le spese sostenute.

Articolo 8 - PAGAMENTO

8.1. Il pagamento dovrà essere effettuato, salvo diverso accordo scritto, contestualmente alla consegna o nei modi e nei termini indicati di volta in volta in offerta. In caso di pagamento mediante lettera di credito, questa dovrà essere aperta entro breve termine dalla conclusione del contratto nella forma più semplice e conforme alle previsioni del contratto, dovrà essere irrevocabile e confermata da primaria banca italiana. Eventuali pagamenti fatti ad agenti, rappresentanti o ausiliari di commercio di Athena non si intendono effettuati finché le relative somme non pervengano alla stessa.

8.2. Qualsiasi ritardo o irregolarità nel pagamento dà ad Athena il diritto di sospendere le forniture o di risolvere i contratti in corso, anche se non relativi ai pagamenti in questione, nonché il diritto al risarcimento degli eventuali danni. Athena ha comunque diritto – a decorrere dalla scadenza del pagamento, senza necessità di messa in mora – agli interessi moratori nella misura del tasso di sconto in vigore nel proprio Paese, aumentato di 7 punti.

8.3. Il compratore è tenuto al pagamento integrale anche in caso di contestazione o controversia. Tuttavia, per quanto riguarda eventuali somme controverse, ha la facoltà di depositarle presso una Banca Italiana fino a quando la controversia non sia stata risolta, vincolando la banca a trasmettere tali somme ad Athena in caso di risoluzione della controversia in senso favorevole a quest'ultima. Non è ammessa compensazione con eventuali crediti, comunque insorti, nei confronti di Athena.

Articolo 9 - RISERVA DI PROPRIETÀ

9.1. Nel caso in cui il pagamento debba essere effettuato – in tutto od in parte – dopo la consegna, i prodotti consegnati restano di proprietà di Athena sino al momento del completo pagamento del prezzo nella misura permessa dalla legge del Paese dove i prodotti si trovano.

9.2. Il compratore si impegna a fare quanto necessario per costituire nel suddetto Paese una valida riserva di proprietà nella forma più estesa consentita, o per porre in essere un'analoga forma di garanzia a favore di Athena.

Articolo 10 - FORZA MAGGIORE ED ECCESSIVA ONEROSITÀ

10.1. Quando si verificano incendi, crolli, inondazioni, mancanza di rifornimenti, perturbazioni nei trasporti, scioperi, serrate o altri eventi dovuti a casi di forza maggiore, che impediscano o riducano sensibilmente la produzione negli stabilimenti di Athena o blocchino i trasporti fra lo stabilimento di Athena ed il luogo di destinazione dei prodotti, il contraente colpito ha diritto ad una proroga fino a 45 giorni (estensibili a 90 nei casi più gravi) dei termini di consegna o ritiro dei prodotti, purché avvisi

tempestivamente per iscritto la controparte del verificarsi del caso di forza maggiore.

10.2. Trascorsi i termini di cui sopra e permanendo la situazione di forza maggiore, l'altra parte potrà risolvere il contratto, facendone pervenire comunicazione scritta con lettera raccomandata con ricevuta di ritorno alla parte inadempiente. Quest'ultima non avrà in tal caso alcun obbligo al risarcimento dei danni.

10.3. Se, per qualsiasi altro motivo imprevedibile ad un imprenditore del settore con normale esperienza, l'esecuzione degli obblighi di Athena sia divenuta – prima della della loro esecuzione – eccessivamente onerosa in rapporto alla controprestazione originariamente pattuita, così da modificare il rapporto stesso per più del 20 per cento, Athena può chiedere una revisione delle condizioni contrattuali e, in mancanza, dichiarare risolto il contratto. In quest'ultimo caso però devono essere risarcite al compratore le spese dal medesimo sostenute in occasione del contratto risolto.

Articolo 11 - CESSIONE DEL CONTRATTO

11.1. Il compratore non può cedere la sua posizione nel contratto od in singoli rapporti obbligatori da questo derivanti senza l'accettazione scritta del venditore: anche in tal caso il compratore rimane comunque solidalmente responsabile col cessionario per le obbligazioni cedute.

Articolo 12 - INTERPRETAZIONE, MODIFICHE, CLAUSOLE INVALIDE

12.1. Per l'interpretazione delle presenti condizioni generali fa fede unicamente il testo italiano delle stesse.

12.2. Eventuali allegati o premesse si intendono parte integrante dei contratti cui si riferiscono. Ogni richiamo ai listini prezzi, condizioni generali od altro materiale di Athena o di terzi si intende riferito ai documenti in vigore al momento del richiamo stesso, salvo non sia diversamente specificato; devono ritenersi annullati i testi corrispondenti in precedenza in vigore fra le parti.

12.3. Le dichiarazioni effettuate od il comportamento tenuto dalle parti durante le trattative o nel corso dell'esecuzione del contratto possono contribuire all'interpretazione del solo contratto cui si riferiscono, e nei limiti in cui non contrastino con le presenti condizioni generali o con gli accordi scritti presi dalle parti in occasione della conclusione del contratto in questione.

12.4. Salvo quanto sopra previsto agli artt. 2.4. e 2.5., ogni modifica od integrazione fatta dalle parti ai contratti cui si applicano le presenti condizioni generali dovrà essere effettuata per iscritto, a pena di nullità. La deroga ad una o più disposizioni delle presenti condizioni generali non deve interpretarsi estensivamente o per analogia e non implica la volontà di disapplicare le condizioni generali nel loro insieme.

12.5. Eventuali variazioni delle condizioni contrattuali concordate tra le parti non costituiscono novazione del contratto, salvo espressa volontà contraria, risultante per iscritto.

12.6. In caso di disposizioni contrattuali invalide od inefficaci, il contratto nella sua globalità va integrato ed interpretato come se contenesse tutte le clausole che, consentono di raggiungere, in modo conforme alla legge, lo scopo essenziale perseguito dall'accordo contenente le clausole in questione.

Articolo 13 - FORO COMPETENTE

13.1. Per ogni controversia relativa o comunque collegata ai contratti cui si applicano le presenti condizioni generali è esclusivamente competente il foro di Vicenza; Athena avrà tuttavia facoltà di agire presso il foro dell'acquirente.

Data _____

Il venditore _____

Il compratore _____

Si approvano espressamente i seguenti articoli:

Art. 2 – Formazione ed oggetto del contratto

Art. 4 – Garanzia

Art. 5 – Reclami

Art. 6 – Norme tecniche e responsabilità del produttore

Art. 7 – Consegna

Art. 8 – Pagamento

Art. 9 – Riserva di proprietà

Art. 10 – Forza maggiore ed eccessiva onerosità

Art. 11 – Cessione del contratto

Art. 13 – Foro competente

Il compratore _____

Article 1 - CONTRACT PROVISIONS

1.1. The present general conditions, exception made for any written derogation/waiver, shall regulate all present and future contracts of sale between the parties. Any general conditions of the purchaser shall not apply to any relationship between the parties if not expressly accepted in writing. Nevertheless, in this case, exception made for any written derogation/waiver, the general conditions of the purchaser shall not prejudice the efficacy of the present general conditions and shall have to be coordinated therewith.

1.2. The reference that may be made to commercial terms (Ex Works, FOB, CIF, etc.) is understood to be made according to the Incoterms of the International Chamber of Commerce in the text in force at the moment of entering the contract.

1.3. All contract of sales between the parties as well as the present general conditions, shall be governed by the Italian law and in particular by the Uniform Law on international sale of goods, ratified by the Law of 21.6.1971, as well as the Uniform Law on the formation of contracts for the international sale of goods ratified on the same day. Any derogation or reference made by the parties to specific articles of the Italian law do not imply an exclusion of the enforcement of the Uniform Laws hereinabove, to the extent of their accordance with the contractual discipline.

1.4. The adhesion to the present general conditions, as well as all subsequent contracts and behaviour of the parties regulated hereby, if not otherwise agreed upon in writing, do not imply the granting to the purchaser of any exclusive right, the existence of any distributorship relation, commission or mandate, with or without agency, nor the granting to the purchaser of the right to use, in any form, the trade-marks or distinctive signs of the purchaser.

Article 2 - EXECUTION AND OBJECT OF THE CONTRACT

2.1. No offer made by agents, representatives and commercial intermediaries of Athena S.p.A. shall be binding if not confirmed by Athena itself.

2.2. During negotiations, the mere sending of the present general conditions shall not imply the acceptance of any offer; nevertheless the general conditions substitute and cancel any general conditions previously proposed by one of the parties.

2.3. The sending by Athena of a price-list or descriptive material of the product not expressly bearing the diction "offer" or an equivalent one, shall not be considered as a proposal. The diction "not binding", "if available" or similar ones inserted by Athena in an offer shall not bind the seller to the terms of the offer even in case of acceptance of said offer by the purchaser, exception made for subsequent written confirmation or conformable execution by Athena. Athena's offer shall be considered firm or irrevocable only if qualified as such in writing by Athena and if containing a validity term of the clause.

2.4. The acceptance of the contract by the purchaser, however effected, shall involve its adhesion to the present general conditions. In case Athena issues an order confirmation, even after entering the contract, it shall be presumed that the terms of the contract correspond to the terms of the order confirmation, except if the purchaser immediately communicates in writing the differences thereof.

2.5. The acceptance, with no expressed reserves by the purchaser of non conformable products for type or quantity shipped different from the terms contained in the purchaser's request, shall imply acceptance by the latter of both the supply and the conditions proposed by Athena. The reserves hereinabove [even if formulated as specifications or modifications of the delivery conditions] shall have no force if not given in writing by the purchaser, immediately after receiving the merchandise.

2.6. All recordings and registrations requested by the state of each party or in the country of destination of the goods, in order to give full efficacy to the contracts governed by the general conditions hereinabove or to one of their clauses, shall have to be carried out by the purchaser at its own care and charge.

2.7. By consenting to these general conditions of sale, the purchaser undertakes not to sell products covered by the contract to trade operators working via e-marketplaces.

Article 3 - SAMPLES, TECHNICAL DRAWINGS AND DOCUMENTS

3.1. It is agreed that weights, dimensions, capacities, prices, performances, colors and other data contained in catalogs, prospects, circulars, advertisements, illustrations, price-lists or other illustrative Athena's documents, as well as the characteristics of samples and models sent by Athena to the purchaser, shall all constitute an approximate guide only. These data shall have binding value only if expressly mentioned as binding in the offer or in the written confirmation from Athena.

3.2. Unless otherwise agreed upon in writing, in case the offer or the acceptance of the purchaser refers to a sample offered by Athena, the latter shall be deemed committed to the characteristics of the sample only within the limits indicated in art. 3.1.

3.3. In case Athena bases its supply to a sample given by the purchaser, it shall be deemed responsible - unless otherwise agreed upon in writing - for

the compliance of its services (within the limits set forth in art. 3.1.) only with the apparent characteristics of the sample.

3.4. Any technical drawing or document enabling the processing or assembling of the products sold or of parts of them given to the purchaser, whether before or after entering the contract, shall remain exclusive property of Athena. The drawing or documents hereinabove shall not be used by the purchaser nor copied, reproduced or transmitted to third parties without the Athena's consent.

Article 4 - WARRANTY

4.1. Save as in this general conditions expressed and unless otherwise agreed upon in writing from time to time, Athena shall guarantee the conformity of the supplied products to what expressly agreed. The warranty for defects shall be limited to the defects of products deriving from defects in planning, material or manufacturing attributable to Athena and shall not be valid in absence of the purchaser's proof of its correct use, maintenance and conservation and of no modification or repair to the products without Athena's consent.

4.2. The warranty shall have a limited duration of 12 months, beginning from the date of delivery and shall be subject to the regular claim made by the purchaser according to the following article, as well as the written request to the seller to carry out a warranty intervention. In order to comply with the request hereinabove, the Athena shall be committed (at its own option), within a reasonable period of the time according to the extent of the claim, alternatively:

- a) to supply the purchaser with products of the same kind and quantity of those proved defective or not in compliance with the agreement, free of charge and freight. In this case, Athena shall have the right to demand, at the expenses of the purchaser, the return of the defective goods, which become its own property;
- b) to repair, at its own expenses, the defective product or modify the product not in compliance with the agreement, carrying out said operation where the products are located or in its own factory. In these cases, all costs relating to the transportation of the products shall be at the purchaser's charge;
- c) to pay compensation for damages to the purchaser by crediting the purchaser an amount equal to the cost of repairing or modifying the products in its own factory;
- d) to declare in writing the termination of the contract, offering to refund the price paid against the return of the supplied products. Except for fraud or gross negligence of Athena, any compensation for damages to the purchaser shall not exceed the invoiced price of the claimed products.

4.3. All "Racing" products designed for competition are sold without any express or implied warranty and Athena declines any responsibility.

4.4. The warranty hereinabove shall absorb and substitute the legal warranty for defects and lack of compliance and exclude any other seller's responsibility, however originated by the supplied products; in particular, the purchaser shall have no right to put forth any other claim for damages, reduction of the price or resolution of the contract. Upon the expiry of the warranty, no request can be made to Athena.

Article 5 - CLAIMS

5.1. The provisions of the Law of 21.6.1971, mentioned in art. 1 still remaining in force:

- a) all claims regarding quantity, weight, color, or quality defects or lack of compliance that the purchaser could notice at the moment of receiving the goods, shall have to be carried out by the purchaser within a short time from the moment the goods reached their destination, however, under penalty of forfeiture, not beyond 15 days from said moment;
- b) all hidden defects and non-conformities (more precisely all non-visible defects on the basis of the verification demanded to the seller by law and by the paragraph hereinabove) shall have to be denounced within a short time from their discovery and, however, under penalty of forfeiture, not beyond 12 months from the date of delivery.

5.2. All claims shall be sent via registered letter addressed to Athena and shall indicate in detail all defects or non conformities. Furthermore, they shall contain a cost estimation for repair or modification of the products on the spot, whenever possible. In absence of the requisites hereinabove, no claim shall be effective.

5.3. Should the claim be found groundless, the purchaser shall have to refund Athena with all the expenses made for the investigation (trips, appraisals, etc.). The same applies in the event that the claim result only partially grounded, up to a percentage not higher than 30% of the claim originally made.

5.4. Items returned for mistaken orders are subject to a 15% re-stocking fee to be deducted from the credit note, with a minimum charge of 20€.

Article 6 - TECHNICAL SPECIFICATIONS AND MANUFACTURER'S RESPONSIBILITY

6.1. Being stated that, as far as the characteristics of the products are concerned, Athena shall follow the laws and technical rules in force in Italy and the purchaser shall assume the whole risk of any difference between

the Italian provisions and the provisions of the country of destination of the products, holding Athena harmless.

6.2. Athena shall be responsible for damages to both persons and property caused by the products sold only in case of gross negligence in manufacturing the products hereinabove is proved; in no case shall Athena be deemed responsible for indirect or consequential damages, loss of production or lack of profit.

6.3. Exception made for the provisions hereinabove, the purchaser shall hold Athena harmless in case of third parties' actions based on responsibilities originated by the products sold to the purchaser and shall pay compensation for the damages resulting from such actions. Athena shall have the right to involve the purchaser who, for its part, shall take all necessary steps to intervene, in any legal action brought by third parties in connection with the products supplied.

Article 7 - DELIVERY

7.1. If not otherwise agreed upon in writing, any sale shall be deemed to be Ex Works, even if expressly agreed upon that the shipment (or part of it) shall effected by Athena; in this case, the latter shall act as agent of the purchaser, being agreed that the transportation shall be done at the risk and charge of the purchaser.

7.2. In case of delayed delivery, the purchaser shall have the right to cancel the undelivered part of the order only after giving notice thereof to Athena by means of a registered letter with return receipt and after having granted Athena a period of 15 working days beginning from the receipt of such notice, within which Athena shall have the possibility of delivering all the products specified in the request and not yet delivered. However, any responsibility for damages caused by delay or lack of delivery, both total or partial, shall be excluded.

7.3. If not otherwise agreed upon, the Ex Works delivery of the products shall take place by means of a written notice thereof (even by telex) to the purchaser that the products are at its disposal; the purchaser shall have a period of time of 3 days from the sending of such notice to take delivery of the products.

7.4. Should the purchaser not take delivery of the merchandise within the terms set forth in the paragraph hereinabove, the purchaser shall have to reimburse all storage charges to Athena fixed in a lump sum equal to 10% of the amount of the invoice concerning said products for each week of delay. Furthermore, upon the expiry of a 30 days term, Athena shall have the right to sell the products on behalf of the purchaser, at any price, deducting from the return the whole amount due (regardless to the payment terms agreed upon), as well as any expenses borne therefor.

Article 8 - PAYMENT

8.1. Unless otherwise agreed upon in writing, payments shall be made at time of delivery or following the terms and conditions set forth from time to time in the offer. In case of payment by letter of credit, it shall have to be opened within a short time from the entering of the contract in the easiest form and in accordance with the provisions of the contract and shall have to be irrevocable and confirmed by a leading Italian bank. Any payment made to agents, representatives or commercial intermediaries of Athena shall not be deemed to have been carried out until the relevant sums are collected by Athena.

8.2. Any delay or irregularity in the payment shall grant Athena the right to suspend deliveries or to terminate the outstanding contracts even if not relevant to the payments at issue, as well as the right to claim damages. However, the seller shall have the right, beginning from due date of the payment, with no need for any intimation to pay, to obtain interests for delayed payment corresponding to the discount rate of the country of the seller increased by 7 points.

8.3. The purchaser shall be bound to fulfill its obligations of entire payment even in case of claims or controversy. In case of disputed amounts, the purchaser may, at its option, deposit the sums object of the controversy in an Italian bank until the controversy has been settled, binding the bank to transfer said sums to Athena should the controversy be settled in its favor. No compensation with any credit however arisen towards Athena shall be accepted.

Article 9 - RESERVATION OF TITLE

9.1. Should the payment be made – in whole or in part – after delivery, the delivered products remain property of the seller until the payment obligations have been entirely fulfilled, within the limits of the law of the country where said products are located.

9.2. The purchaser shall have the obligation to take all necessary steps to constitute, in the country where the products are located, a valid property reservation in the most extensive form permitted or to create a similar form of guarantee in favor of Athena.

Article 10 - FORCE MAJEURE

10.1. Should fires, collapses, floods, lack of supplies, transportation difficulties, strikes, lockouts or any events beyond control of the respective parties hinder or sensibly reduce the production in the factories of one of the parties, or

prevent the transportation between the factories and the place of destination of the products, the injured party shall have the right to obtain a prorogation of the delivery or collection terms of the products of 45 days, provided that timely notice of such event of force majeure is given to the other party. The prorogation term may be extended in the most critical cases to 90 days.

10.2. Upon the expiry of the terms hereinabove in the continuation of the event of force majeure, the other party shall have the right to terminate the contract by giving written notice thereof to the defaulting party by registered letter with return receipt. The defaulting party shall in this case have no obligation to pay damages.

10.3. Should the fulfillment of Athena's commitments, owing to any reason unforeseeable by an entrepreneur of the field with normal experience, have become – before their fulfillment – excessively onerous compared with the contractual obligation originally agreed upon, such as to modify the ratio by over 20 per cent, Athena shall have the right to request a revision of the contractual conditions or, failing such revision, to terminate the contract. In case of termination, all expenses borne by the purchaser for terminating the contract, shall have to be reimbursed to the purchaser.

Article 11 - ASSIGNMENT OF THE CONTRACT

11.1. The purchaser shall have no right to assign his position in the contract or in individual binding relationships deriving from the contract without Athena's written consent thereof. The purchaser remains, however, jointly and severally responsible with the assignee for the assigned obligations.

Article 12 - INTERPRETATION, MODIFICATION, INVALID CLAUSES

12.1. The Italian text of the present general conditions shall be the only authentic text for the interpretation thereof.

12.2. Any exhibit or preamble shall be considered part of the contracts they refer to. Any reference made to price-list, general conditions or other material either by Athena or by third parties, shall be deemed made to the documents in force at the moment of said reference, unless otherwise specified. All correspondent texts previously in force between the parties shall have to be considered cancelled.

12.3. The statements made or the behavior held by the parties during the execution of the contract may contribute to the interpretation only of the contract they refer to and only where not in contrast with the present general conditions or with the written agreements made by the parties at the time of entering the contract at issue.

12.4. Excepting the provisions set forth in articles 2.4. and 2.5., any modification or integration made by the parties to the contracts in connection with the present general conditions, shall be void unless set forth in writing. Any derogations to one or more dispositions of the present general conditions shall not be interpreted extensively or for analogy and shall not imply the will to disregard all present general conditions.

12.5. Unless otherwise agreed upon in writing, no variation to the contractual conditions between the parties shall constitute modification of the contract.

12.6. In case of invalidity or ineffective contractual provisions, the whole contract shall have to be integrated and interpreted as containing all the clauses that allow reaching, in compliance with the law, the essential aim pursued by the agreement containing the provisions hereinabove.

Article 13 - COMPETENT JURISDICTION

13.1. Any dispute relating to or however in connection with the contracts governed by the present general conditions shall be settled by the courts of Vicenza as the exclusive competent jurisdiction. The seller shall however have the right to take action in the Purchaser's Court.

Data _____

The seller

The purchaser

The provisions set forth in the articles hereunder are expressly accepted.

Art. 2 – Execution and Object of the Contract

Art. 4 – Guarantee

Art. 5 – Claims

Art. 6 – Manufacturer's Responsibility

Art. 7 – Delivery

Art. 8 – Payment

Art. 9 – Reservation of Title

Art. 10 – Force Majeure

Art. 11 – Assignment of the Contract

Art. 13 – Competent Jurisdiction

The purchaser



ATHENA RACE
WHEEL SPACERS
BOLTS RACE
ATHENA
100% HSS - quattro Dotti
TVL - Made in Italy
100% Parafuso de alto
qualidade para TVL
100% hochwertige TVL-
Bolzen - Made in Italy
ATHENA



Athena S.p.A

Via delle Albere, 13
36045 Alonte (VI) - Italy
Tel. +39 0444.72.72.72
motorsport@athena.eu

Facebook icon @ AthenaMotorsport
athena.eu 